

# FRANC3D

## SIERRA Tutorial

Version 8.6

SIERRA is a product of  
Sandia National Labs

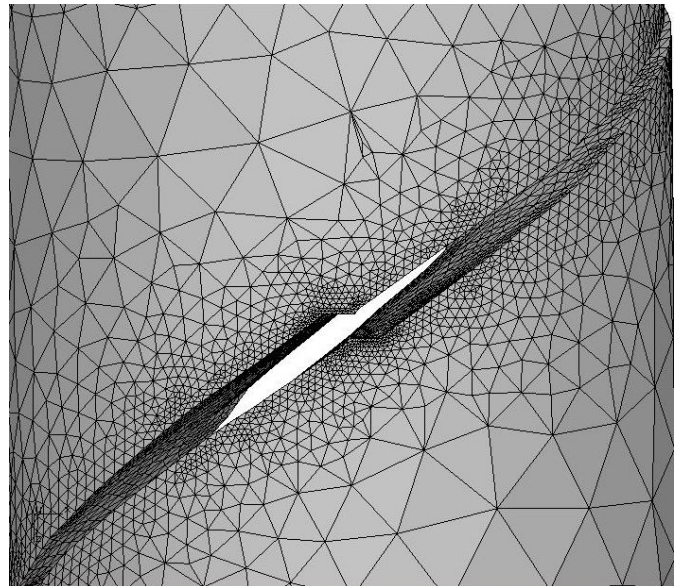

Fracture Analysis Consultants, Inc  
[www.fracanalysis.com](http://www.fracanalysis.com)

Revised: Nov 2024

# **Table of Contents:**

1.0	Introduction.....	4
2.0	Tutorial 1: Crack Insertion and Growth in a Cube .....	6
2.1	Step 1: Create the SIERRA FE Model .....	6
2.2	Step 2: Reading SIERRA FE Model into FRAN3D.....	7
	Step 2.1: Importing Complete SIERRA FE Model .....	7
	Step 2.2: Select the Retained Items in the FE Model .....	9
	Step 2.3: Displaying the FE Model.....	11
2.3	Step 3: Importing and Subdividing the Model.....	12
2.4	Step 4: Insert a Crack .....	19
	Step 4.1: Define a new Crack from FRAN3D Menu .....	19
	Step 4.2: Insert Cracks from Files.....	25
2.5	Step 5: Static Crack Analysis .....	28
	Step 5.1: Select Static Crack Analysis .....	28
	Step 5.2: Select FE Solver .....	30
	Step 5.3: Select SIERRA Analysis Options.....	30
2.6	Step 6: Compute Stress Intensity Factors.....	32
2.7	Step 7: Manual Crack Growth.....	33
	Step 7.1: Select Grow Crack.....	34
	Step 7.2: Specify Fitting and Extrapolation.....	36
	Step 7.3: Specify Crack Front Template.....	39
2.8	Step 8: Automatic Crack Growth .....	40
	Step 8.1: Open FRAN3D Restart File .....	40
	Step 8.2: Select Crack Growth Analysis.....	41
	Step 8.3: Specify Growth Rules.....	42
	Step 8.4: Specify Fitting and Template Parameters.....	44
	Step 8.5: Specify Growth Plan.....	44
	Step 8.6: Specify Analysis Code.....	45
2.9	Step 9: SIF History and Fatigue Life .....	47

Step 9.1: Select SIFs Along a Path .....	47
Step 9.2: Select SIFs For All Fronts .....	49
Step 9.3: Select Fatigue Life Predictions .....	50
2.10 Step 10: Resume Growth with Larger Submodel .....	59
Step 10.1: Extract and Save Crack Geometry .....	60
Step 10.2: Restart from Saved Crack Geometry .....	61
Step 10.3: Combine SIF Histories .....	66

## 1.0 Introduction

This tutorial introduces the fracture simulation capabilities of FRANC3D Version 8 and SIERRA. FRANC3D is introduced by analyzing a single surface crack in a SIERRA finite element (FE) model of a cube.

Subsequent tutorials (see the FRANC3D Tutorials #2-14 document) build on this first example and describe additional capabilities and features of the software. It is intended that the user perform operations as they are presented, but you can experiment and consult other reference documentation whenever necessary.

The FRANC3D menu and dialog button selections are indicated by bold text, such as **File** menu. Window regions along with dialog options, fields and labels are underlined. Model names and file names are indicated by *italic text*.

The FRANC3D main window is shown in Fig 1.1. When you start the tutorial, the first thing to do is set the working directory using the **File** → **Work Directory** menu option, Fig 1.1.

Before or after a model is imported, you can set the FE model units, Fig 1.2. The selected units are applied to plots and figures that FRANC3D might display and are used during crack growth in combination with fatigue crack growth rate data, which also has units.

You can also set your preferences; it is helpful to set the path to the SIERRA executable. You can view the preferences using the **Edit** → **Preferences** menu option. The Preferences dialog is described in Section 5.4 of the FRANC3D Reference document.

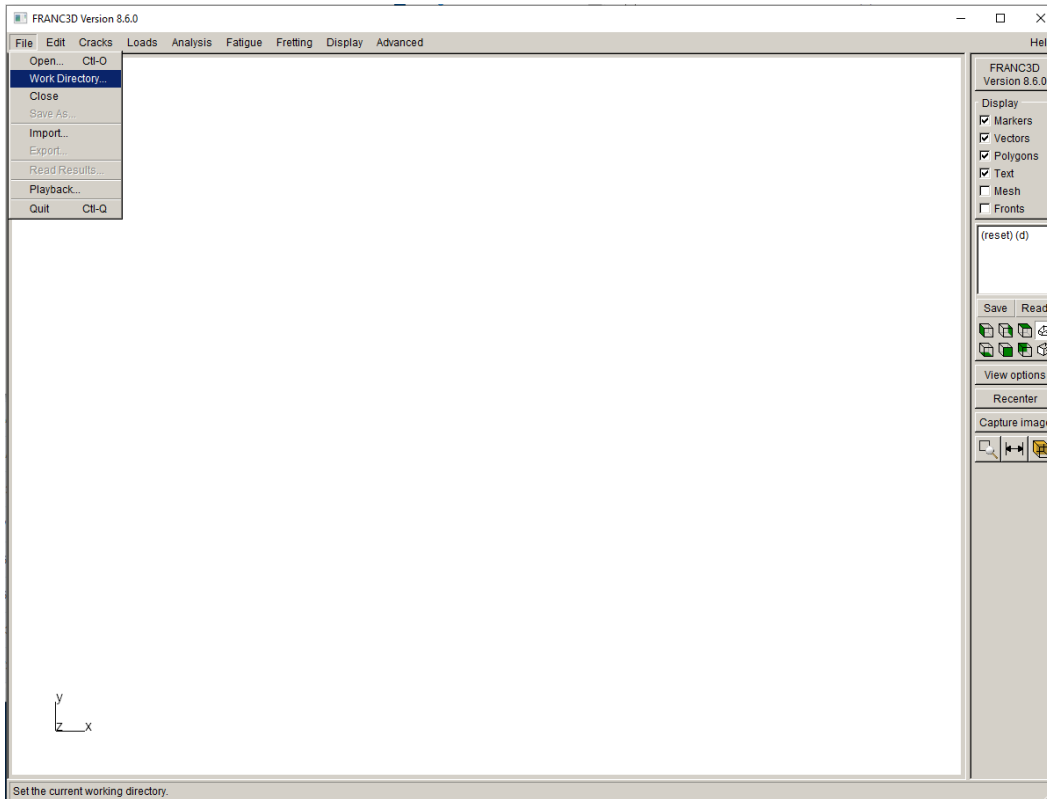

Figure 1.1 FRANC3D main window – Work Directory menu option.

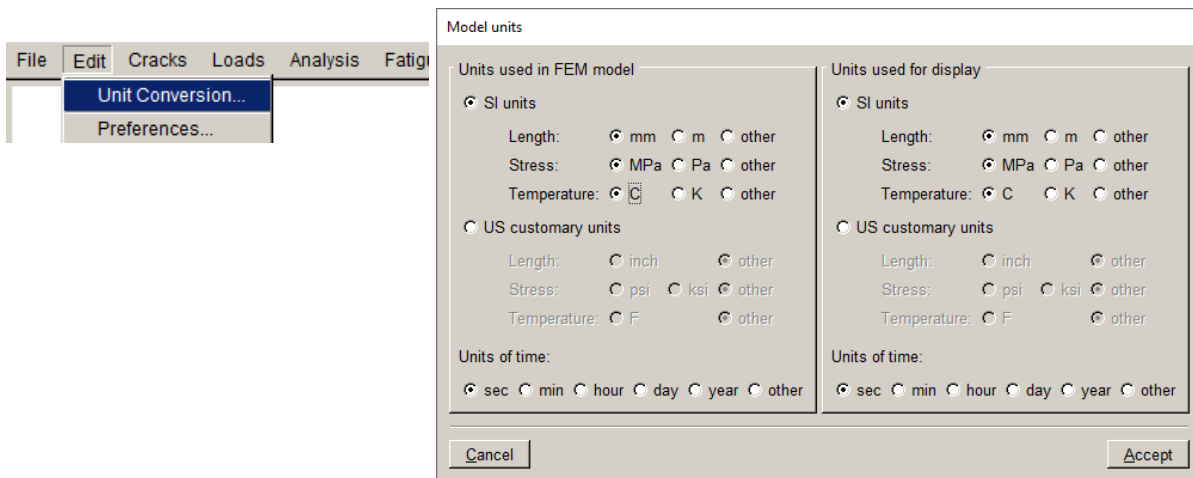

Figure 1.2 FRANC3D FE model unit conversion menu option and dialog.

## 2.0 Tutorial 1: Crack Insertion and Growth in a Cube

In this tutorial, a single surface crack in a cube under far-field tension is modeled. It is assumed that the user is familiar with a pre-processor for SIERRA. Once the FE model is created, the FRANC3D steps to: 1) read the model, 2) insert a crack, 3) perform the SIERRA analysis, and 4) compute stress intensity factors, are all described.

### 2.1 Step 1: Create the SIERRA FE Model

First, you must create a cube model using any pre-processor for SIERRA. We outline the steps to create the FE model with boundary conditions to ensure that you have a model that can be used with FRANC3D.

1. Create a 10x10x10 cube geometry; units of length are mm.
2. Subdivide the edges for meshing, using 10 to 20 subdivisions.
3. Define the element type as quadratic; use brick or tetrahedral elements to mesh the volume.
4. Define the material properties; elastic modulus (E) is 10000 and Poisson's ratio is 0.3; units for E are MPa.
5. Boundary conditions consist of displacement constraints on the bottom surface and uniform traction (a negative pressure) on the top surface. The bottom surface is constrained in the y-direction, the bottom left edge is also constrained in the x-direction, and the point at the origin is also constrained in the z-direction. The top surface traction is 10 MPa.
6. Write the files (*Sierra\_Cube.i*, *Sierra\_Cube.e*, *Sierra\_Cube.g*).

The resulting model is shown in Fig 2.1.

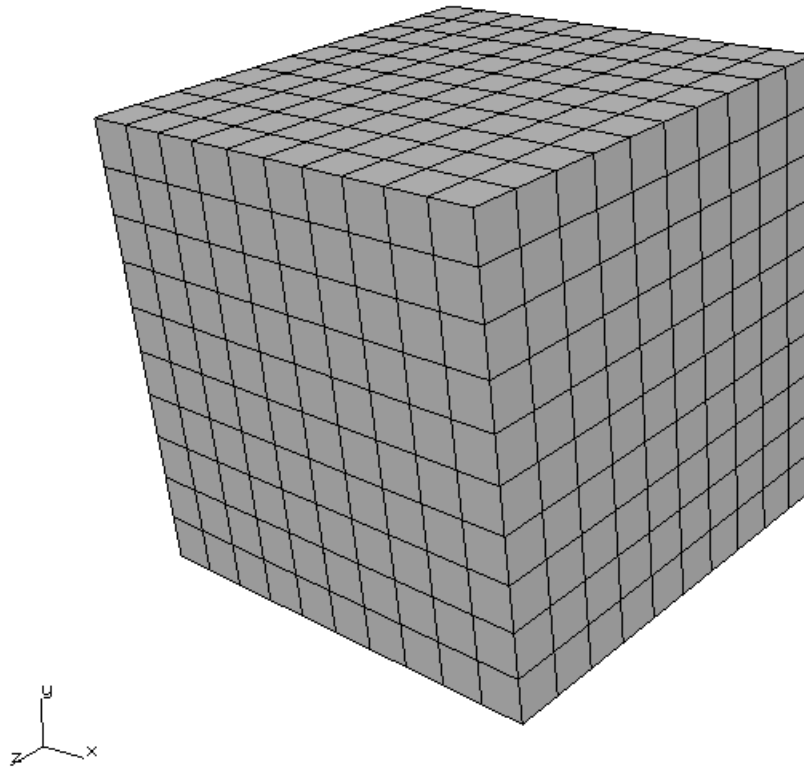

Figure 2.1 SIERRA cube meshed with brick elements.

## 2.2 Step 2: Reading SIERRA FE Model into FRANC3D

Once the SIERRA FE model is created and the files are saved, we proceed with importing the FE model into FRANC3D. We use the *Sierra\_Cube.i* file that was created in the previous step.

You can choose to do either Step 2 or Step 3 (see Section 2.3).

### *Step 2.1: Importing Complete SIERRA FE Model*

From the FRANC3D menu (see Fig 1.1), select **File** → **Import**, Fig 2.2. In the dialog shown in Fig 2.3, choose Complete Model and select **Next**.

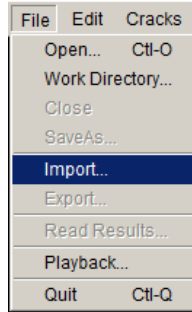

Figure 2.2 File Import menu option.

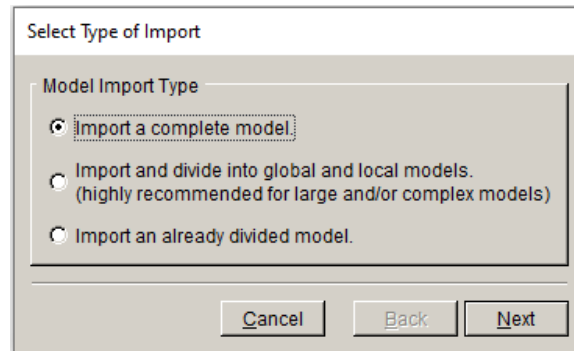

Figure 2.3 Model Import Type dialog.

Switch the Mesh File Type radio button in the Select Import Mesh File window, Fig 2.4, to SIERRA and select the file name for the model, *Sierra\_Cube.i*, and then select **Next**.

Note that the mesh file type can be set in the Preferences if you always use the same analysis code.



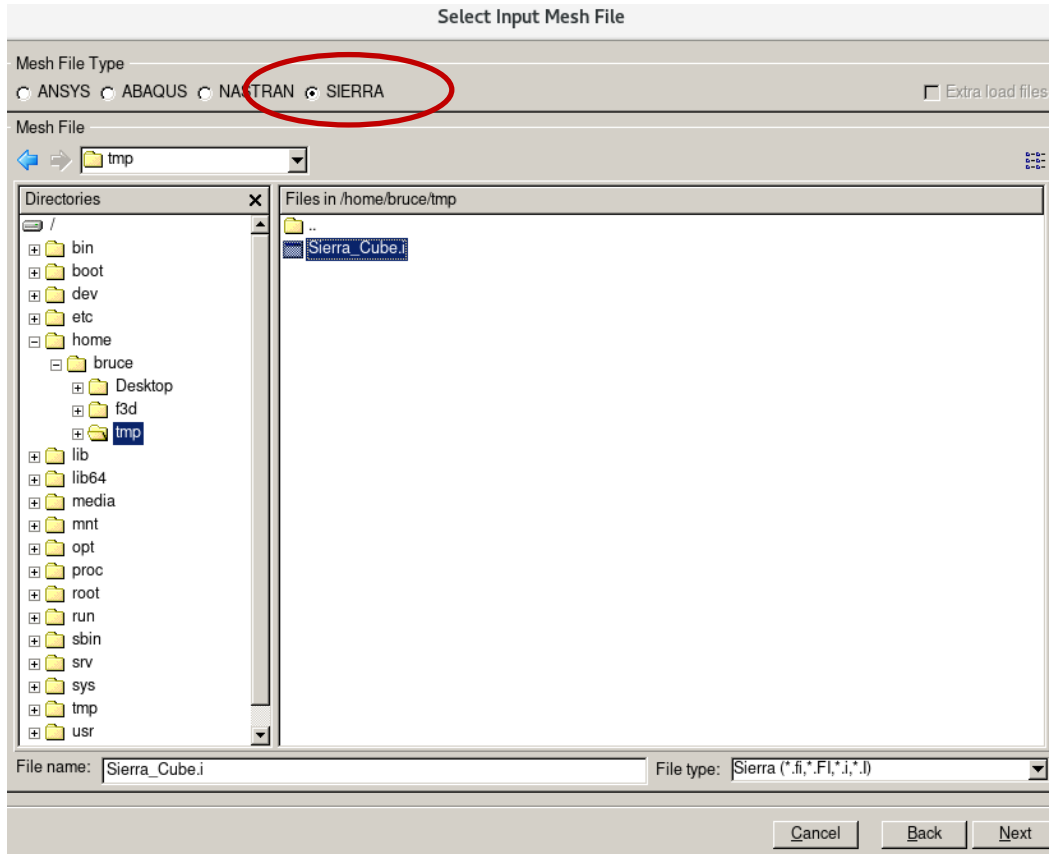

Figure 2.4 Select Input Mesh File dialog box.

### ***Step 2.2: Select the Retained Items in the FE Model***

The next dialog, Fig 2.5, allows you to choose the mesh surface facets that are retained. Surfaces with boundary conditions are blue, Fig 2.6, and turn red when selected, Fig 2.7. You can rotate the model to view all surfaces. We retain the surfaces with boundary conditions (top and bottom of the cube) by choosing **Select All**. The boundary conditions will be transferred automatically to the new mesh once a crack is inserted.

Select **Next** to proceed. The Units dialog will be displayed; if you have already set the units using the **Edit** menu, just select **Finish**.

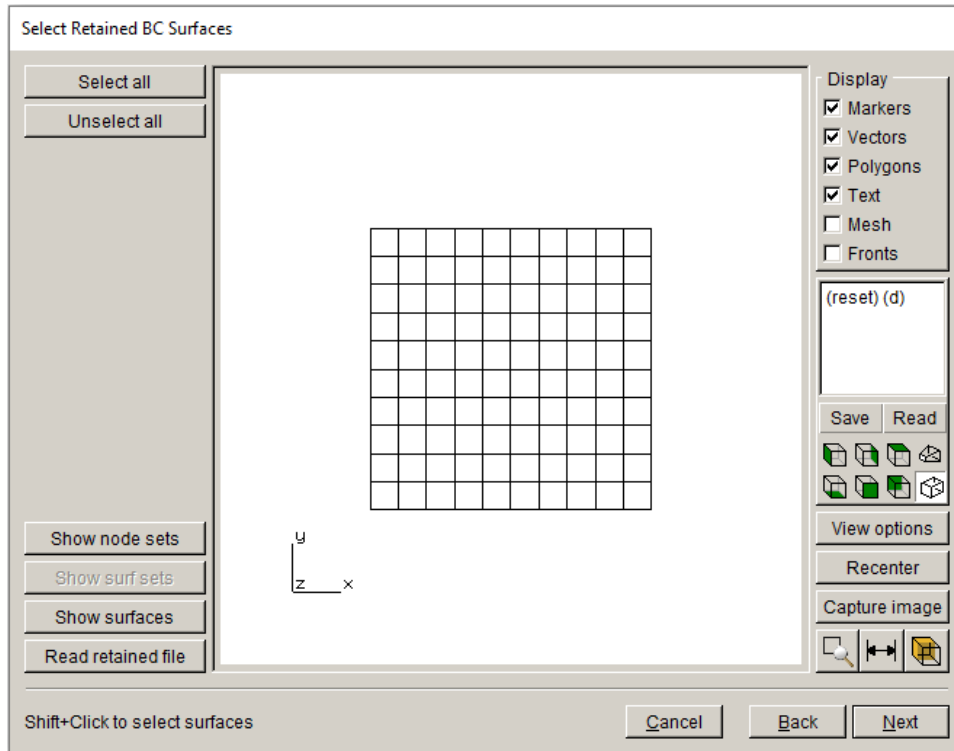

Figure 2.5 Select Retained BC Surfaces wizard panel.

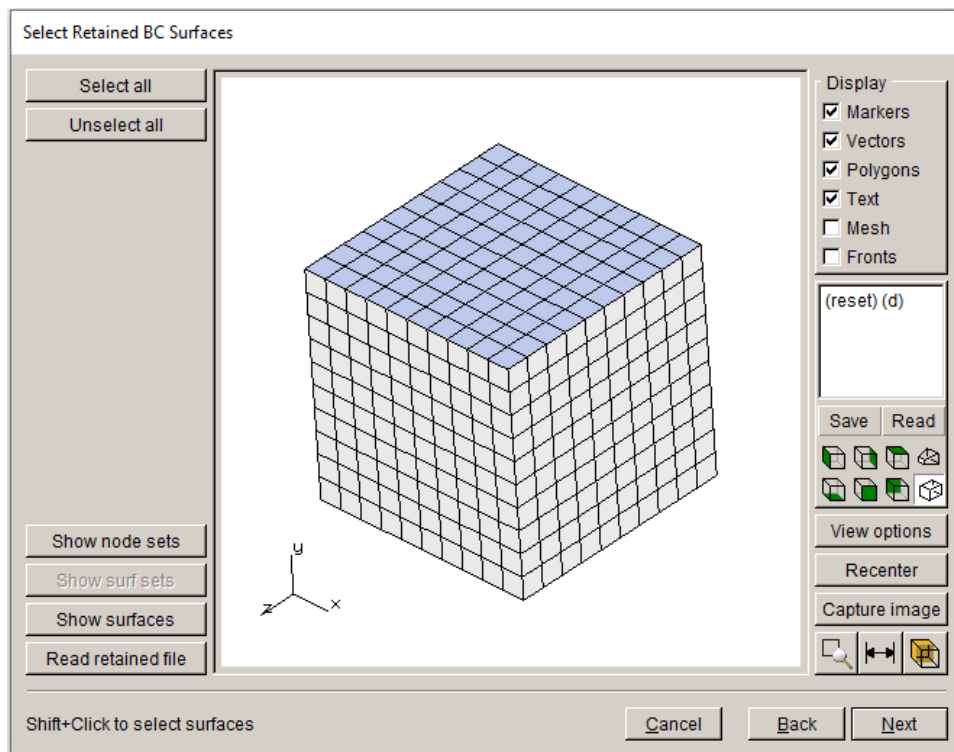

Figure 2.6 SIERRA Model retain BC Surfaces wizard panel - Unselected Surface

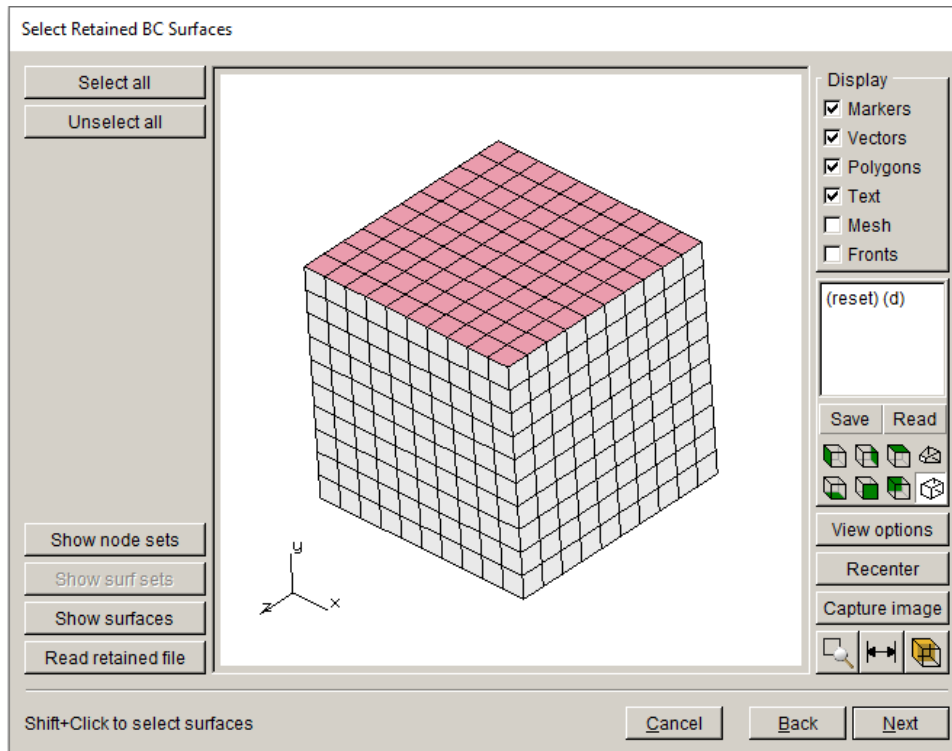

Figure 2.7 SIERRA Model retain BC Surfaces wizard panel – Selected Surface

### Surface Mesh NOT Retained

The surface mesh facets do not have to be retained, and if a crack is inserted into a surface that has boundary conditions, then the surface mesh must not be retained. In such a case, the boundary condition data is mapped to the remeshed surface. In practice, transfer of boundary condition data is simpler and more precise if the surface mesh is retained, but sometimes this is not possible. FRANC3D will automatically transfer the boundary condition data to the new mesh in either case.

### ***Step 2.3: Displaying the FE Model***

The model is displayed in the FRANC3D modeling window, Fig 2.8. You can turn on the surface mesh, or manipulate the model view by rotating, *etc.* Fig 2.8 shows the retained mesh on the top surface (retained bottom surface is not visible) where the traction boundary conditions are applied. See Section 2 of the Reference document for a description of the view manipulation.

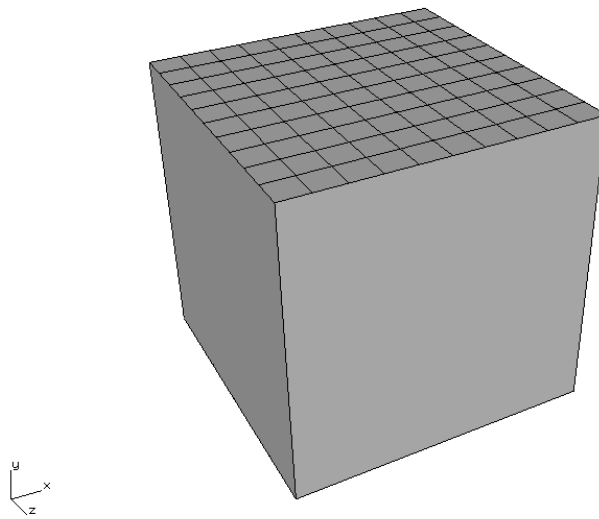

Figure 2.8 SIERRA model imported into FRANC3D with retained facets on the top surface.

If you have not set a working directory (using the **File** → **Work Directory** menu option), FRANC3D might present the dialog shown in Fig 2.9 prior to displaying the model. Select **Yes** to set the work directory as the folder containing the SIERRA files. Many files are created during a crack growth simulation, and it is best to keep them together in one folder.

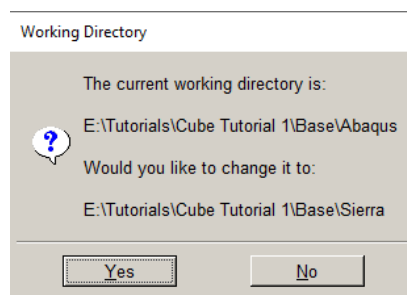

Figure 2.9 Set Working Directory dialog.

### 2.3 Step 3: Importing and Subdividing the Model

If you chose to do Step 2 above, close the model using the **File** → **Close** menu option before starting this step.

The SIERRA model can be split into smaller parts before inserting the crack. Go to **File** → **Import** and choose the Import and divide into global and local models radio button, Fig 2.10. Select **Next**, and then choose the *Sierra\_Cube.i* model, Fig 2.11. Remember to set the Mesh File Type radio button to SIERRA.

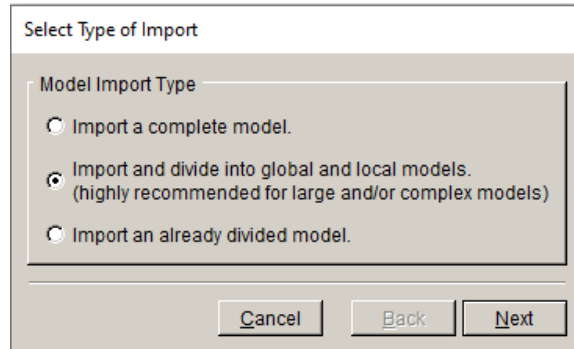

Figure 2.10 Model Import Type dialog with Import and divide selected.

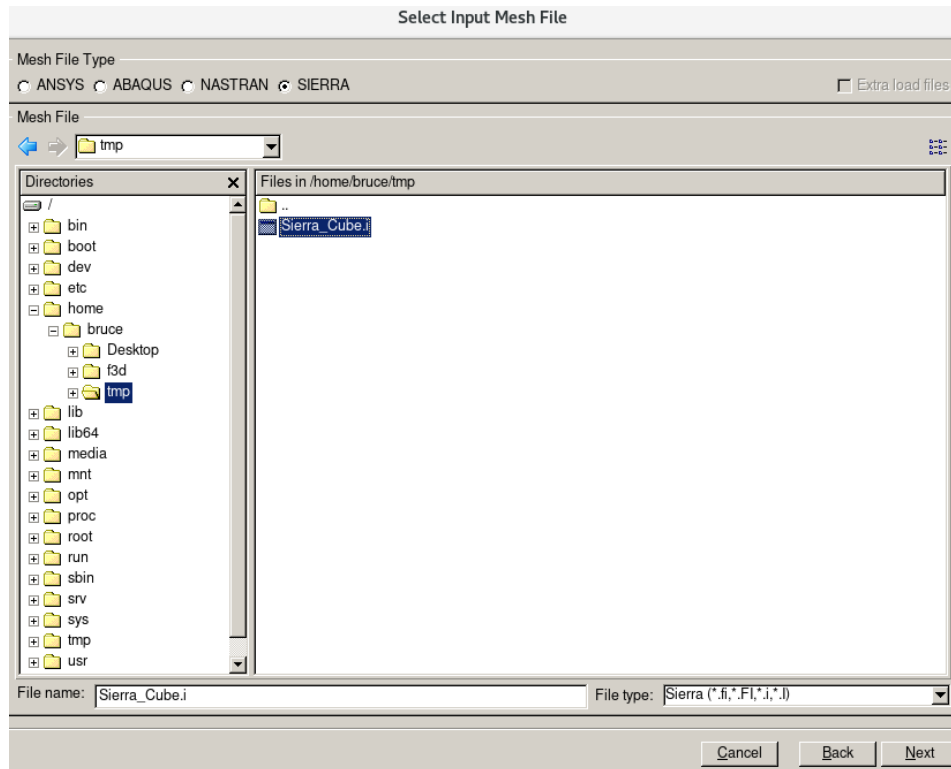

Figure 2.11 Select Input Mesh File selection.

Instead of the Retain BC Surfaces dialog (see Fig 2.5), the Define a Local Submodel window, Fig 2.12, appears. Figs 2.13 and 2.14 show two of the submodel selection tools. Using the options on the left, a submodel is selected; elements to be retained in the submodel appear red, and the selection is confirmed using the **Crop** button. See Section 4.5 of the Reference document for a more complete description of the submodeling tools.

For this tutorial, the rectangular Rubberband Box is used to create a smaller portion of the cube, Fig 2.15, which has an exposed face for crack insertion.

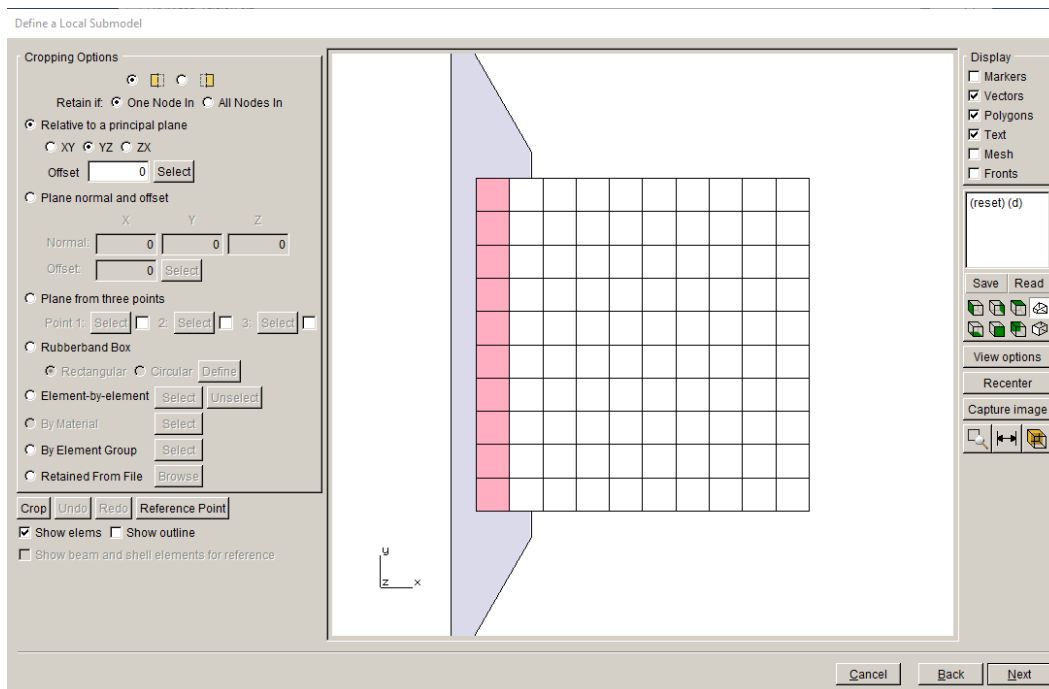

Figure 2.12 Define a Local Submodel Window

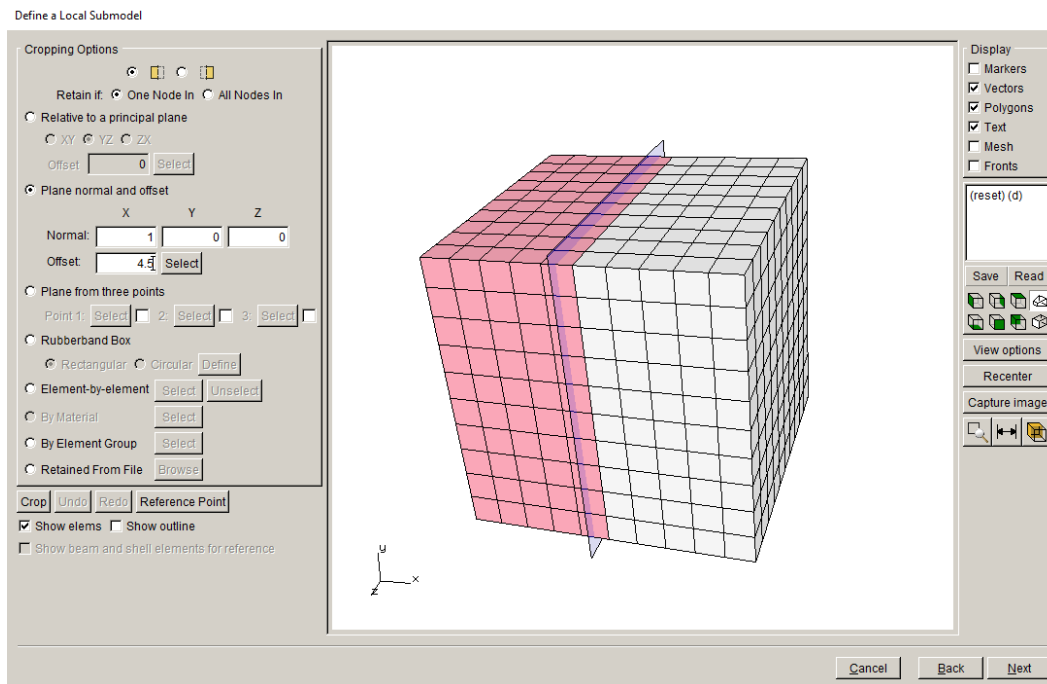

Figure 2.13 Plane Cutting tool – red elements will be retained by **Crop**.

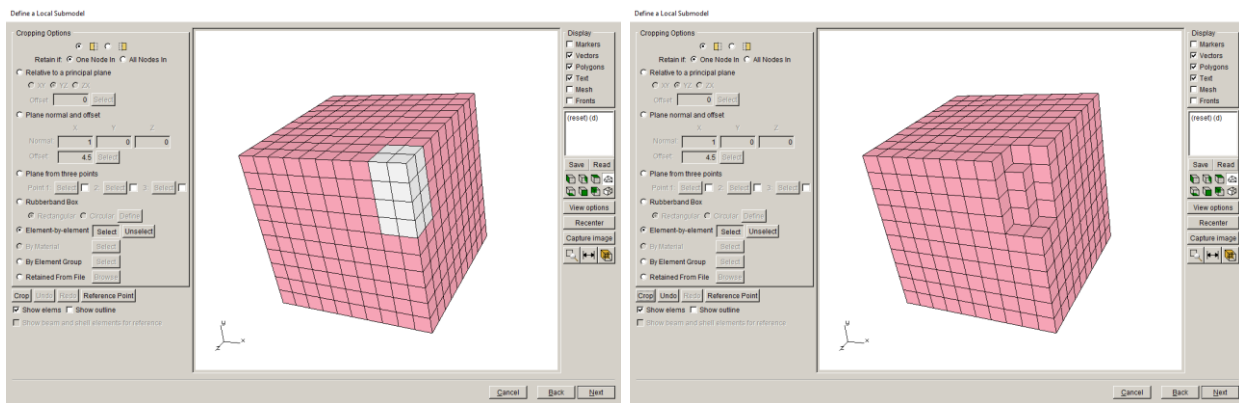

Figure 2.14 Element-by-Element cropping by selecting elements to remove.

We are inserting a surface crack that is normal to the y-axis (loading direction) and located on the +z surface, and the selection in Fig 2.15 is designed for this. Use the Rectangular option of the Rubberband Box to select and **Crop** a small portion of the model.

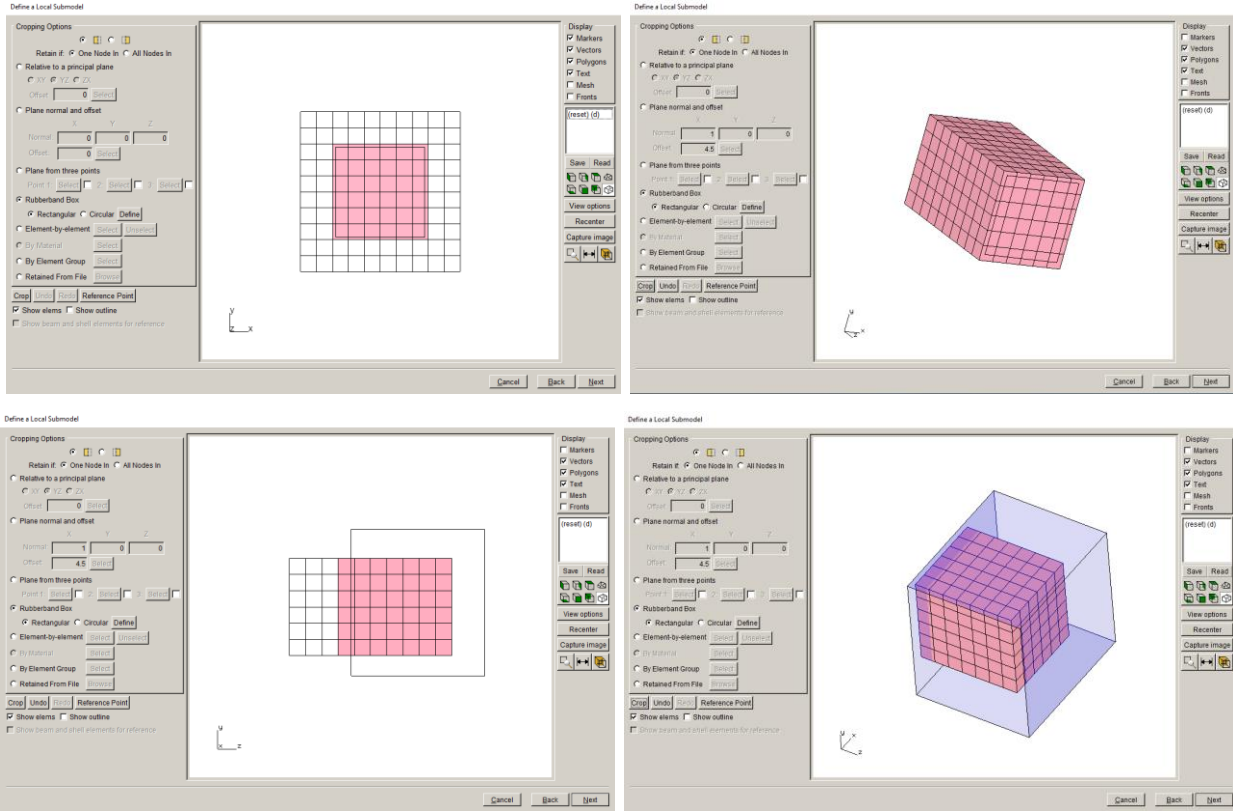

Figure 2.15 Rectangular Rubberband Box tool used to select a submodel.

Once the elements have been selected and cropped, select **Next**. The Save Files dialog appears, Fig 2.16. Choose the names of the local and global models and their location; we use the default file names and the working directory that was set earlier. Select **Next**.

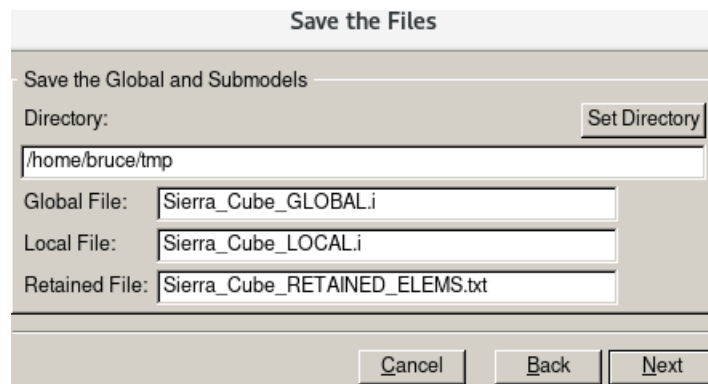

Figure 2.16 Local/Global model save dialog.



If the local cropped model has a surface with boundary conditions, then the Select Retained BC Surfaces window (see Fig 2.5) appears. The cropped selection in Fig 2.15 avoids all surfaces with boundary conditions. However, if there are SIERRA node sets or surfaces in the local model, then the Select Retained BC Surfaces window is still displayed, Fig 2.17. Just select **Next** to proceed.

The model units, Fig 2.18, must be set. As defined in Step 1, the units for length are mm and the units for stress are MPa. The temperature and time units are not needed for this tutorial.

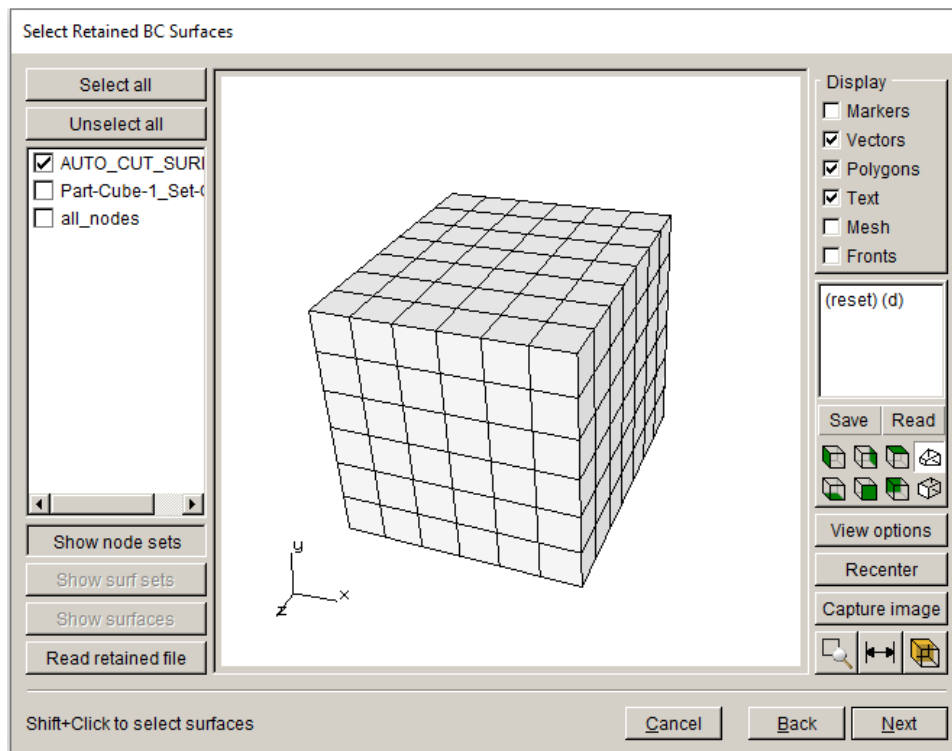

Figure 2.17 Select Retained BC Surfaces wizard panel – showing named node sets.

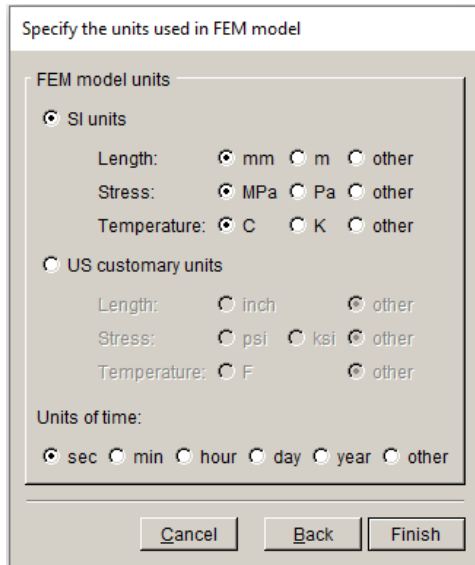

Figure 2.18 FE Model units

Select **Finish** and the local model is displayed in the main FRANC3D window, Fig 2.19. The cut-surface mesh facets are retained, while the front surface where the crack will be inserted does not have retained facets.

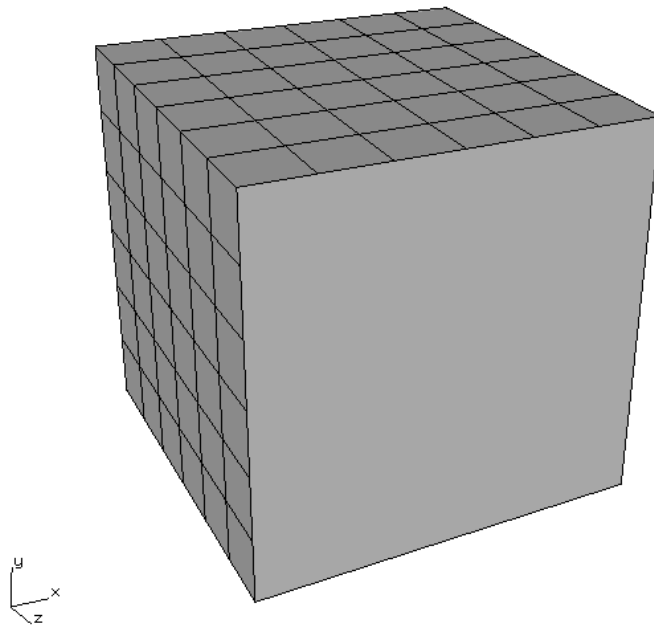

Figure 2.19 Local model with retained mesh facets on the cut-surface.

## 2.4 Step 4: Insert a Crack

We now insert a half-penny surface crack into the model. The local submodel from Section 2.3 is used, as opposed to the full model from Section 2.2. In Step 4.1, we describe how to define a new crack, and in Step 4.2, we describe how to insert a flaw from a file.

Note that you cannot insert a crack into a cracked model. If you want to try both types of crack insertion, you will have to re-import the uncracked model to insert a crack from a file; inserting a crack from a file will be used in subsequent steps and other tutorials.

### *Step 4.1: Define a new Crack from FRANC3D Menu*

From the FRANC3D menu, select **Cracks** → **New Flaw Wizard**, Fig 2.20. The first panel of the wizard, Fig 2.21, allows you to select the flaw type; a crack with zero volume is the default. We select the Save to file and add flaw radio button so that the *.crk* file is saved for subsequent tutorials. Note that the Symmetry surface crack option is only displayed if symmetry cracks are turned on in the Preferences (see Section 5.2 in the Reference).

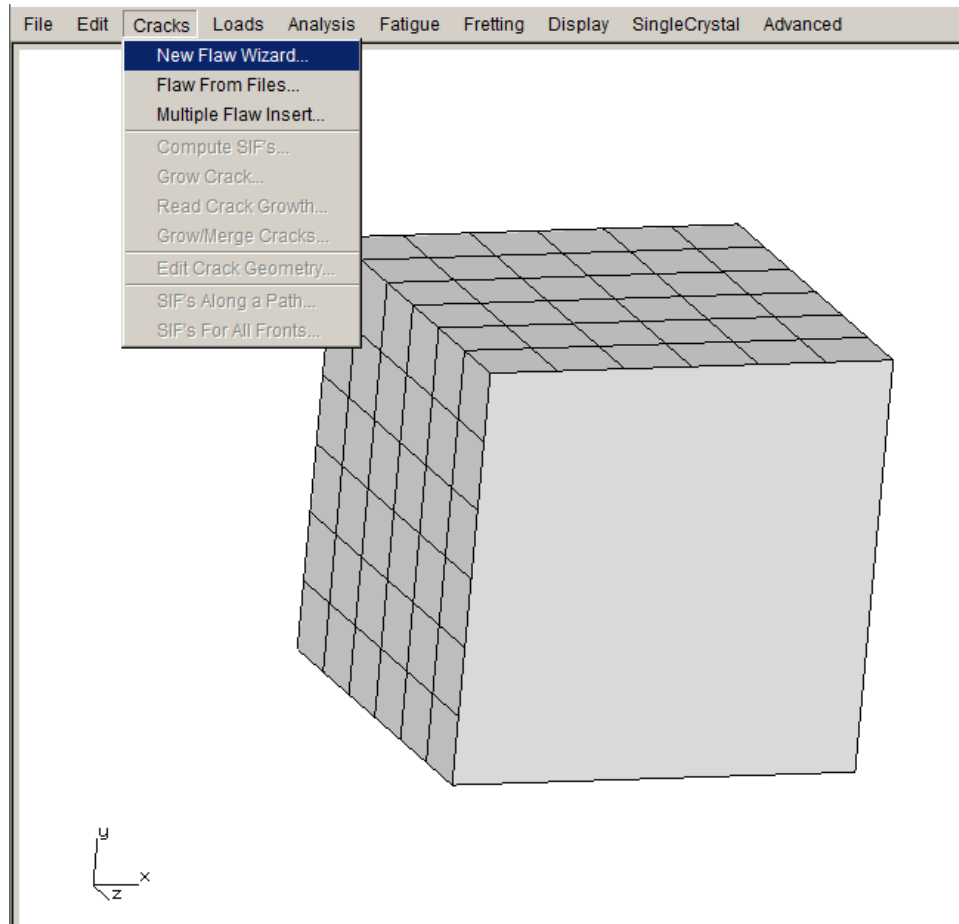

Figure 2.20 New Flaw Wizard menu item selected.

Select **Next**. The second panel, Fig 2.22, lets you choose the crack shape; the default is the ellipse, which is what we want. Select **Next**. The crack is a circle with radius=1, centered on the cube's front (+z) face, and parallel to the xz-plane (normal to y).

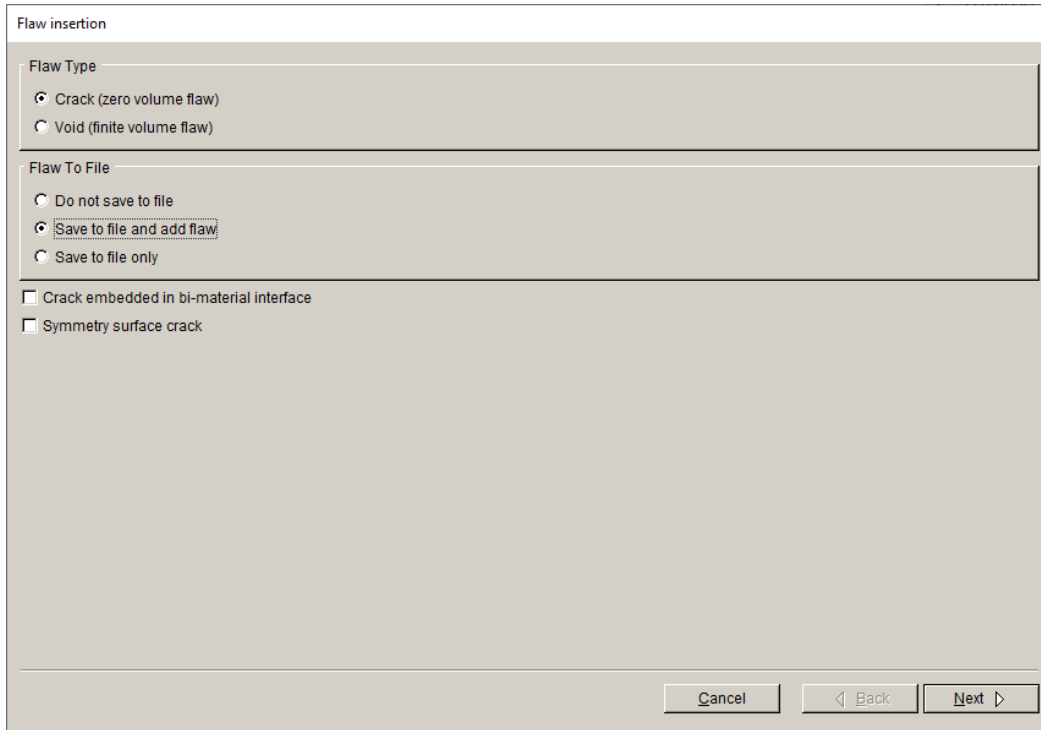

Figure 2.21 New Flaw Wizard first panel – Crack (zero volume flaw) selected.

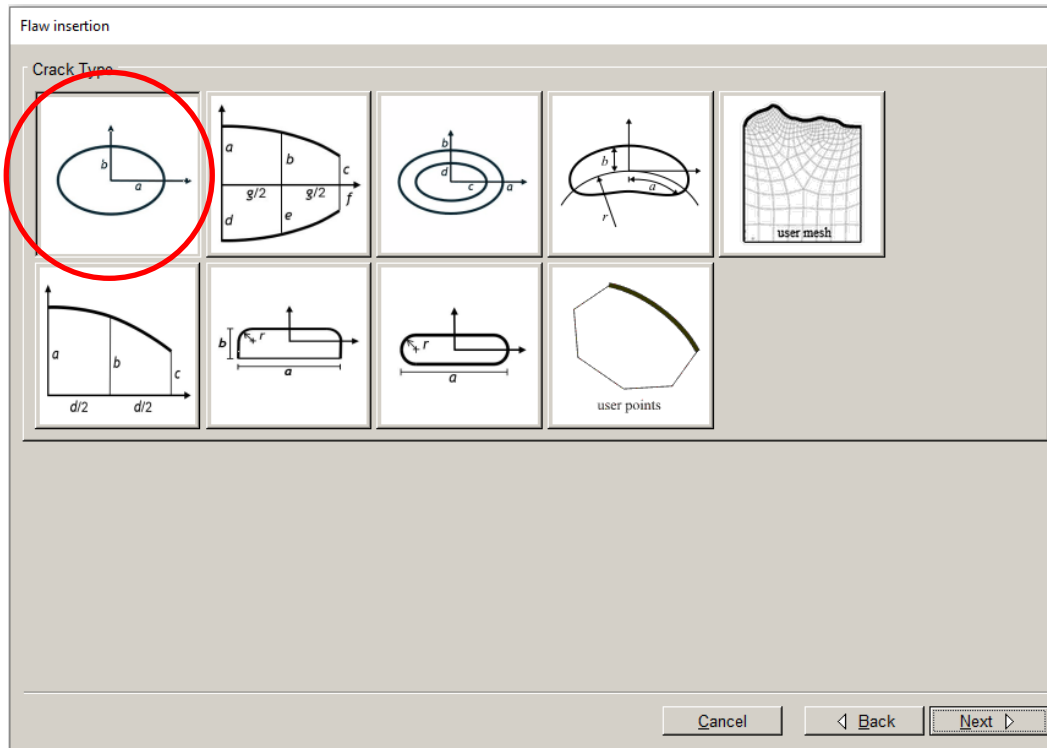

Figure 2.22 New Flaw Wizard second panel – choose ellipse shape.

The third wizard panel lets you set the dimensions for the ellipse, Fig 2.23; set  $a=1$  and  $b=1$ . Select **Next**.

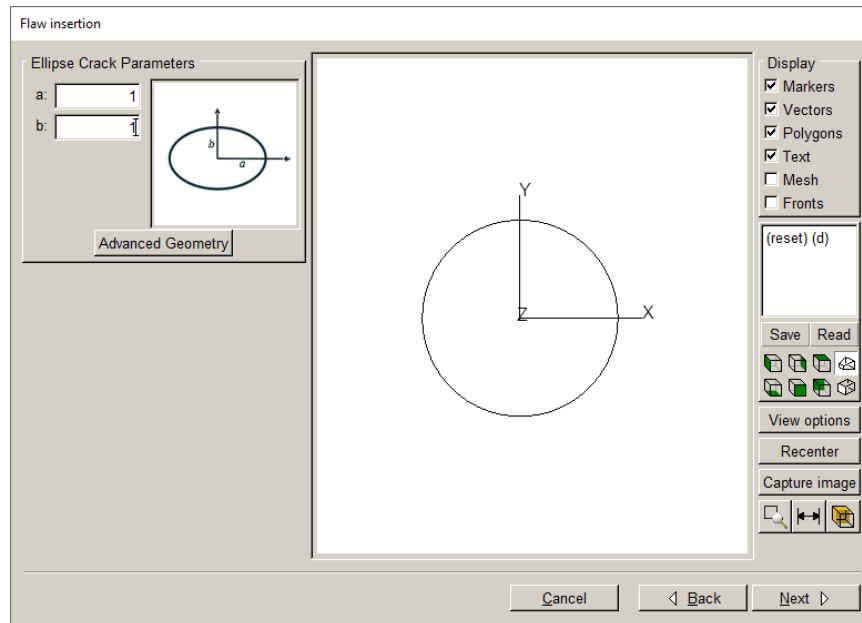

Figure 2.23 New Flaw Wizard third panel – set ellipse dimensions.

The fourth panel lets you set the crack location and orientation, Fig 2.24. We place the crack at the center of the front face at coordinates (5,5,10) and rotate the crack 90 degrees about the Global x-axis. Select **Next**.

The final panel allows you to set the crack front mesh template parameters, Fig 2.25; use the defaults. In practice, the default template radius is based on the crack dimensions and might need to be adjusted depending on the model and crack. Select **Finish**.

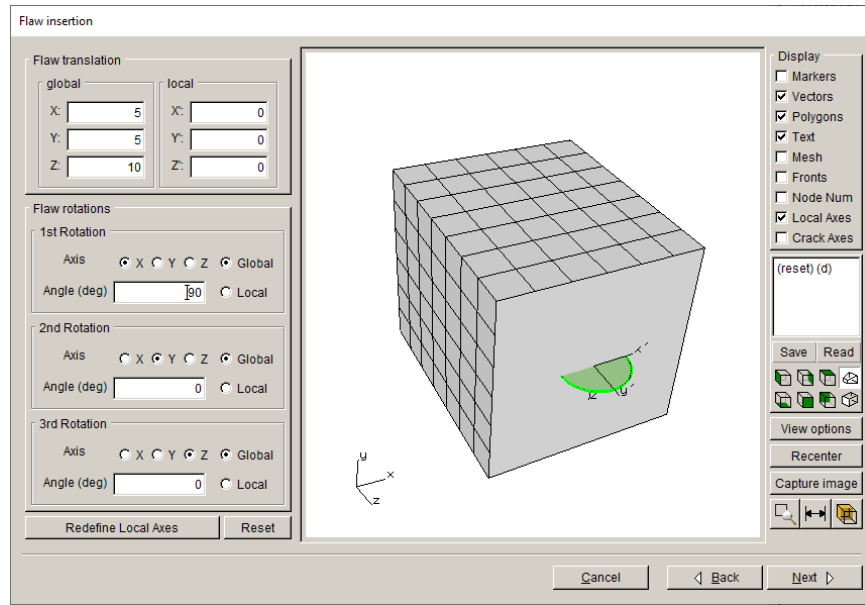

Figure 2.24 New Flaw Wizard fourth panel – set crack location and orientation.

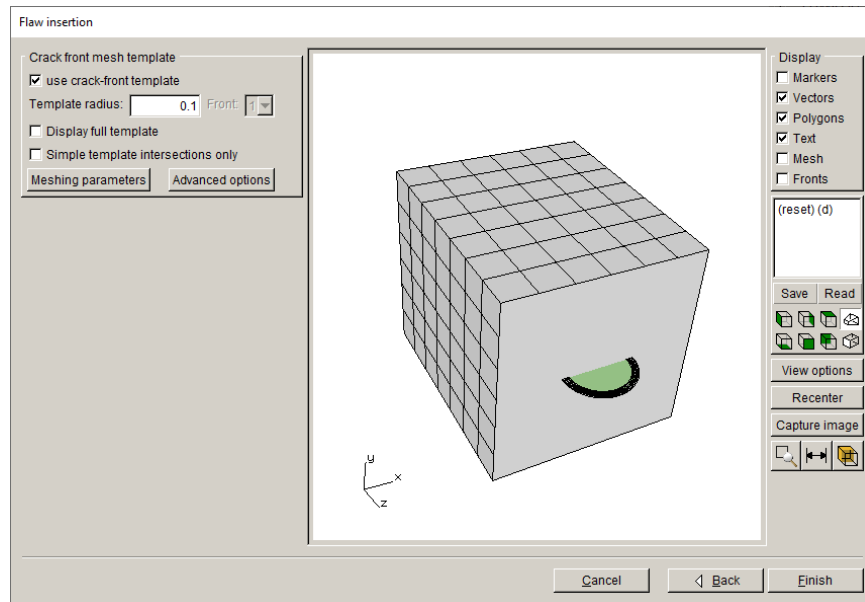

Figure 2.25 New Flaw Wizard final panel – set template mesh parameters.

At this point, you will be asked to specify the *.crk* file name, Fig 2.26; we call it *Cube\_Crack.crk*. Select **Accept**.

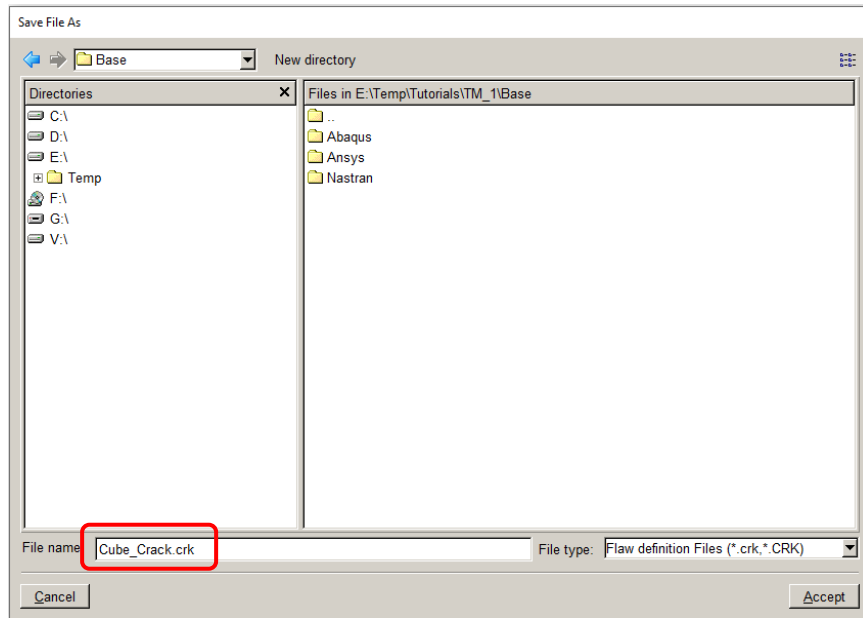

Figure 2.26 New Flaw Wizard final panel – save file as.

The crack is inserted into the model and remeshing occurs. A **Flaw Insertion Status** window is displayed during this process, Fig 2.27. There are three stages: geometric intersection of the crack with the model, surface meshing and volume meshing. The resulting model is displayed in the main FRANC3D window, Fig 2.28; the surface mesh is turned on in this image.

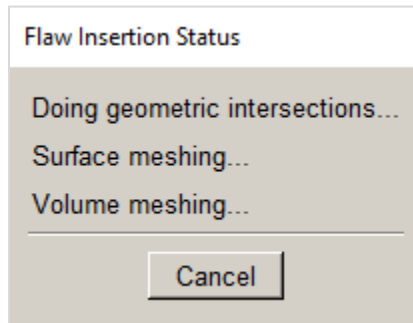

Figure 2.27 Flaw Insertion Status window.



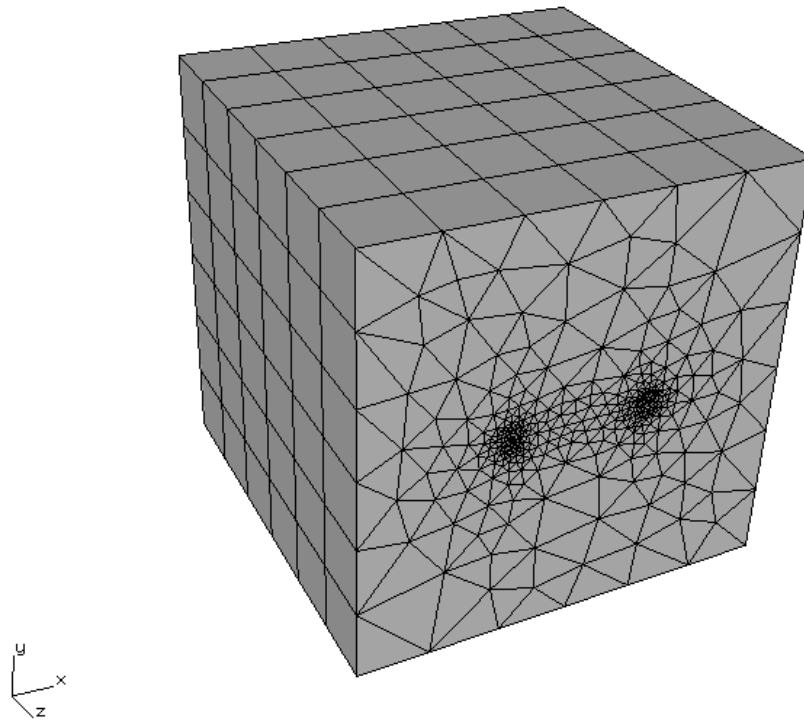

Figure 2.28 Remeshed cracked local model with surface mesh turned on.

#### ***Step 4.2: Insert Cracks from Files***

If you want to try this step, you must **Close** the model from Step 4.1 and re-import the original uncracked (local) model.

From the FRANC3D menu, select **Cracks** → **Flaw From Files**, Fig 2.29. The first panel, Fig 2.30, lets you select the .crk file. Choose the *Cube\_Crack.crk* file name and select **Accept**. This crack was created using the **New Flaw Wizard** with the save to file option in Step 4.1. The flaw being added is a circle with radius=1, centered on the cube's front face, and parallel to the xz-plane.

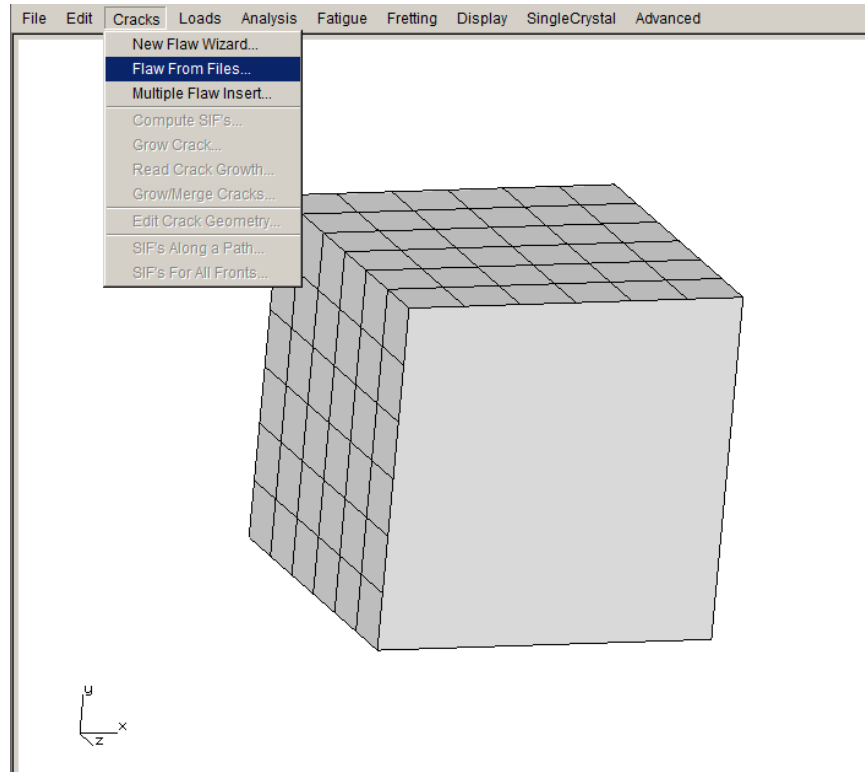

Figure 2.29 Flaw From Files option in Crack menu.

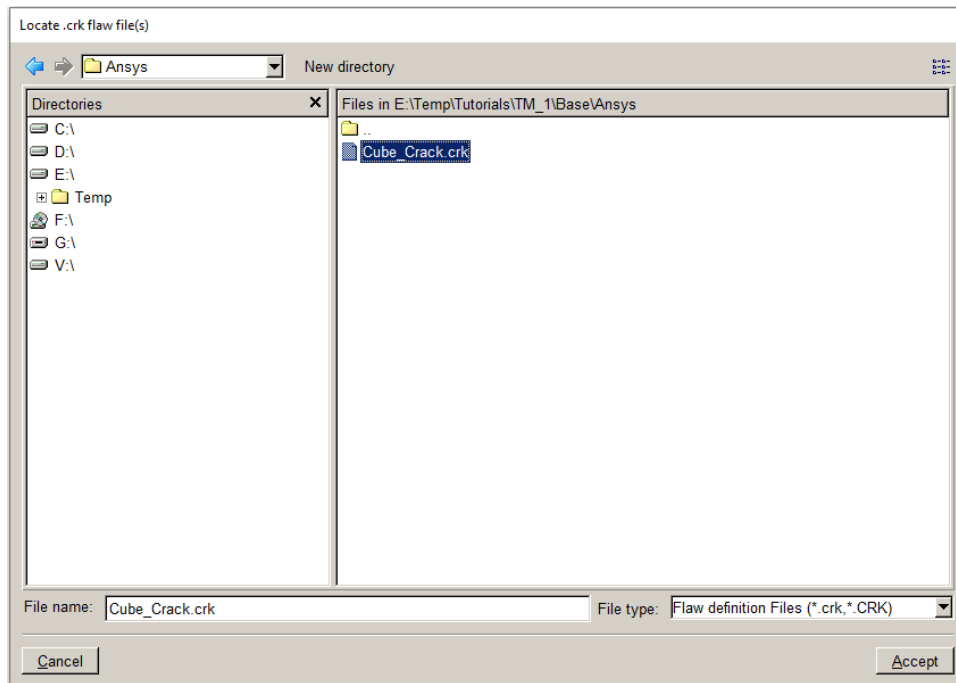

Figure 2.30 Flaw from file dialog to select .crk file.

The next panel, Fig 2.31, allows you to adjust the location of the flaw. The orientation cannot be changed. The final panel, Fig 2.32, allows you to set the template mesh parameters. Use the default settings and select **Finish** to complete the insertion and remeshing.

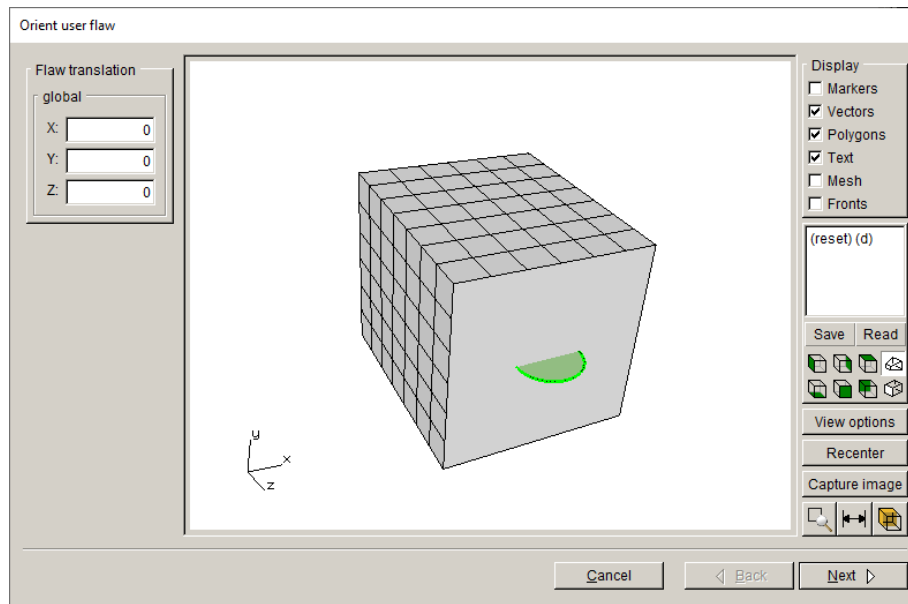

Figure 2.31 Flaw wizard panel to set location.

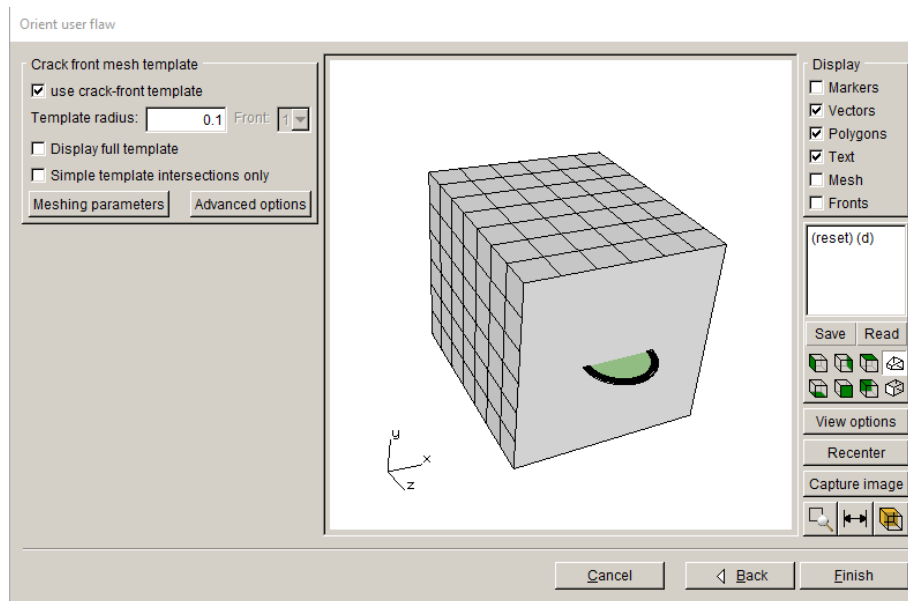

Figure 2.32 Flaw geometry shown in the model with crack template mesh.

## 2.5 Step 5: Static Crack Analysis

Once the crack is inserted and the model is remeshed, we perform a stress analysis using SIERRA, which provides the displacement results that are needed to compute stress intensity factors (SIFs). Typically, you would run a “static crack analysis” of the initial crack prior to running automated crack growth; this allows you to verify that the crack model is consistent with the uncracked model. You can compare displacement contours, using the SIERRA post-processor, for the original uncracked and cracked models to verify that the crack model is valid.

You might also insert the crack with a bigger or smaller template radius to verify that the computed SIFs are accurate; there should be no notable change in SIFs for a reasonable template.

### *Step 5.1: Select Static Crack Analysis*

From the FRANC3D menu, select **Analysis** → **Static Crack Analysis**, Fig 2.33. The first panel, Fig 2.34, requests that you enter the file name for the FRANC3D data.

We call it *Sierra\_Cube\_Subdivide.fdb*; select **Next** once you enter a File Name.

Note that you cannot use the initial uncracked *Sierra\_Cube.i* or *Sierra\_Cube\_LOCAL.i* file names, because a new *.i* file will be created during the analysis. The original uncracked *.i* files are reused for each step of crack growth.

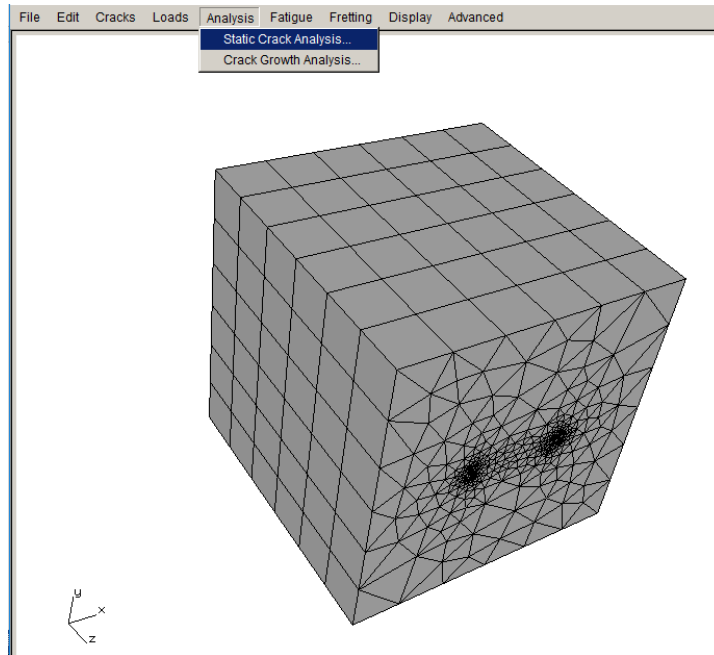

Figure 2.33 Static Crack Analysis menu

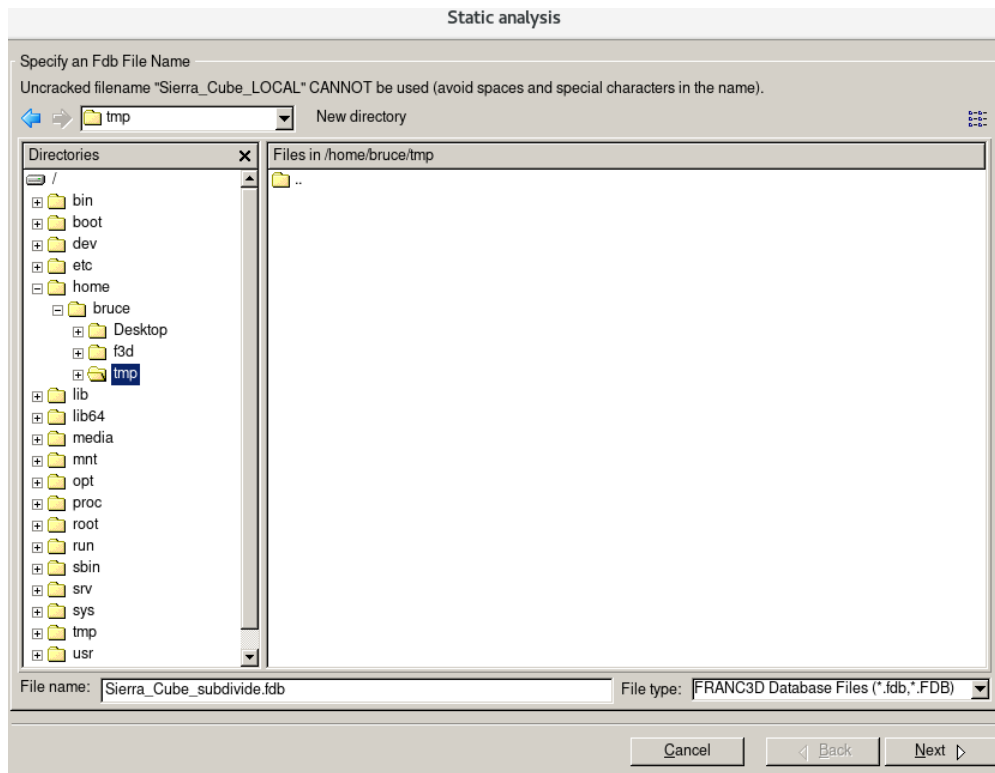

Figure 2.34 Static Analysis wizard first panel – File Name

### ***Step 5.2: Select FE Solver***

The next panel, Fig 2.35, allows you to specify the solver; choose SIERRA and select **Next** (button not shown in Fig 2.35). If this panel does not show up, the SIERRA solver has been chosen automatically.

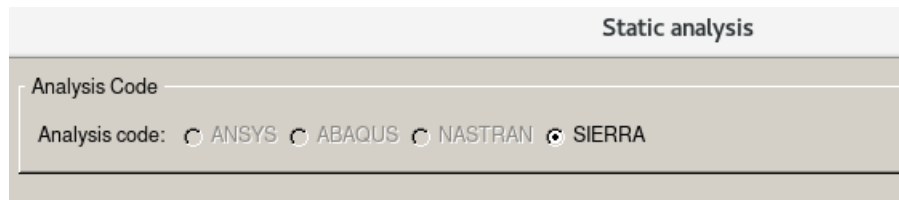

Figure 2.35 Static Analysis wizard second panel – choose solver.

### ***Step 5.3: Select SIERRA Analysis Options***

The next panel, Fig 2.36, allows you to specify the SIERRA output and analysis options. The model is a sub-model and must be connected to the global model, so the Connect to global model box is checked automatically if the FRANC3D submodeler tool was used. The AUTO\_CUT\_SURF and GLOBAL\_CONNECT\_SURF node sets, created by the FRANC3D submodeling tool, are used to recombine the local cracked portion with the global portion.

Click **Finish** to start SIERRA running (in batch/background mode). FRANC3D writes files and then attempts to execute SIERRA based on the SIERRA Executable information (Fig 2.36). You can monitor the FRANC3D CMD window and SIERRA output files for errors or messages.

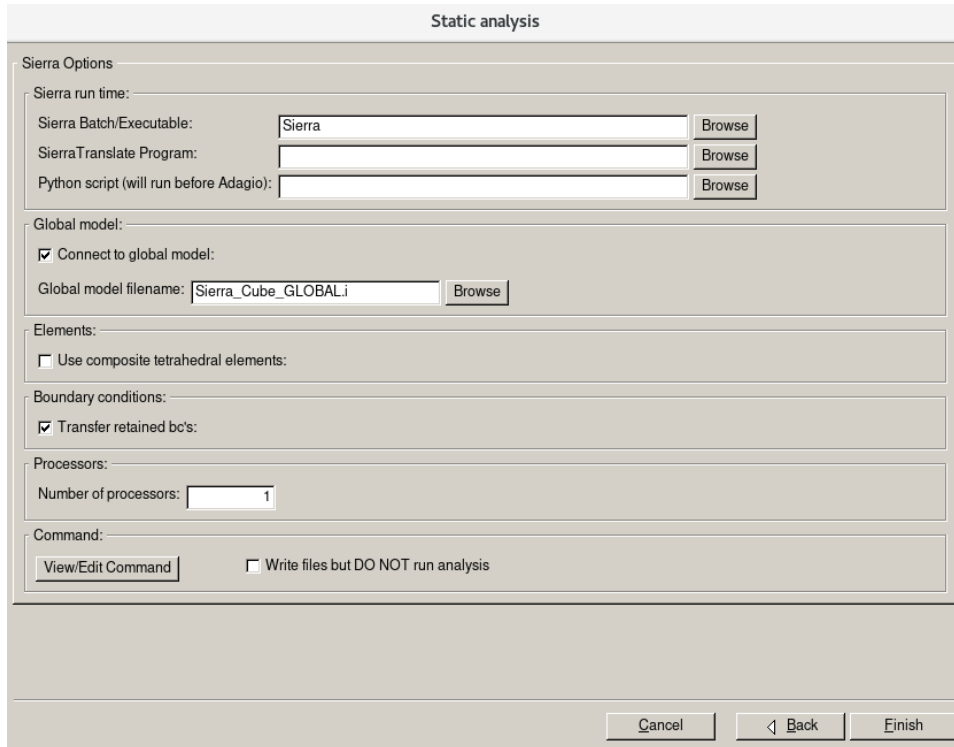

Figure 2.36 Static Analysis wizard third panel – SIERRA output options

Note that if SIERRA does not run, you will see a message in FRANC3D indicating that SIFs cannot be computed because there are no displacements, or you might see a message indicating that FRANC3D cannot find or open the *.dtp* file. You can review the SIERRA files for errors. The SIERRA executable (and path to it) will depend on the installation and operating system.

Choosing Write files but DO NOT run analysis in Fig 2.36 will create all the files without running SIERRA, if the analysis needs to be run later or on a different computer.

If you need to run SIERRA on a different computer, you must bring the results file (*.dtp*) back to the working folder, and then you can use the **File** → **Read Results** menu option to import the results into FRANC3D.

## 2.6 Step 6: Compute Stress Intensity Factors

Once the SIERRA analysis is done, we can compute SIFs. From the FRANC3D menu, select **Cracks** → **Compute SIFs**, Fig 2.37. The Stress Intensity Factor dialog is displayed, Fig 2.38. You should use the M-integral, but you can check that the Displacement Correlation results are similar. Select **Finish** and the SIFs Plot window is displayed, Fig 2.39. You can view the three modes of stress intensity factors (SIFs) using the upper tabs: KI, KII and KIII; mode II and III values should be negligible compared to mode I.

The units for SIFs are  $\text{MPa}\sqrt{\text{mm}}$ . The SIFs are plotted versus the normalized crack front length, starting from point A – see the left image in Fig 2.39. SIFs are computed at element midside nodes along the front, so the values do not start at exactly zero.

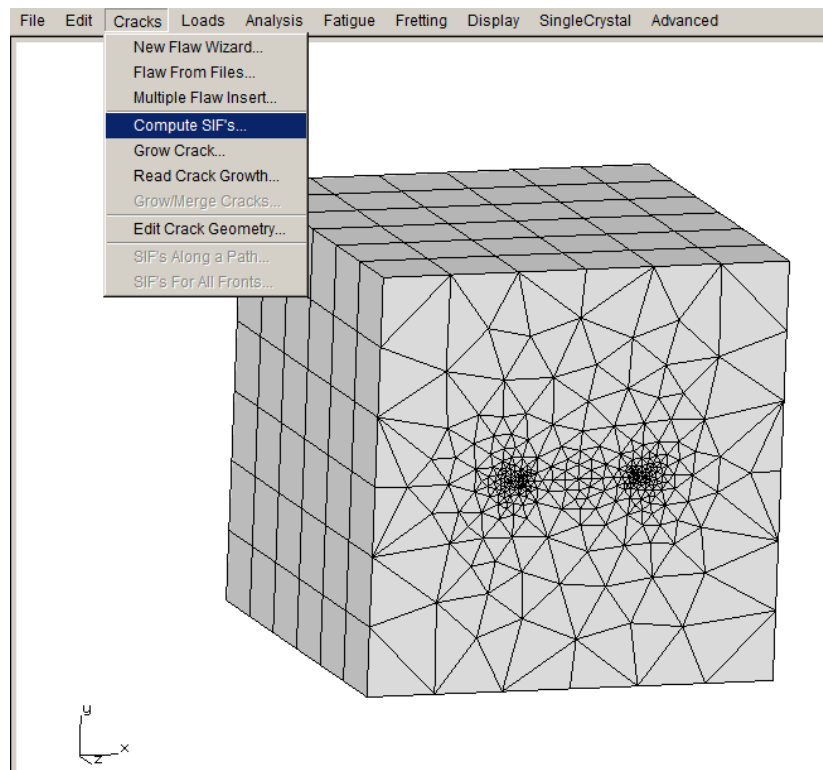

Figure 2.37 Compute SIFs selected from the Cracks menu.



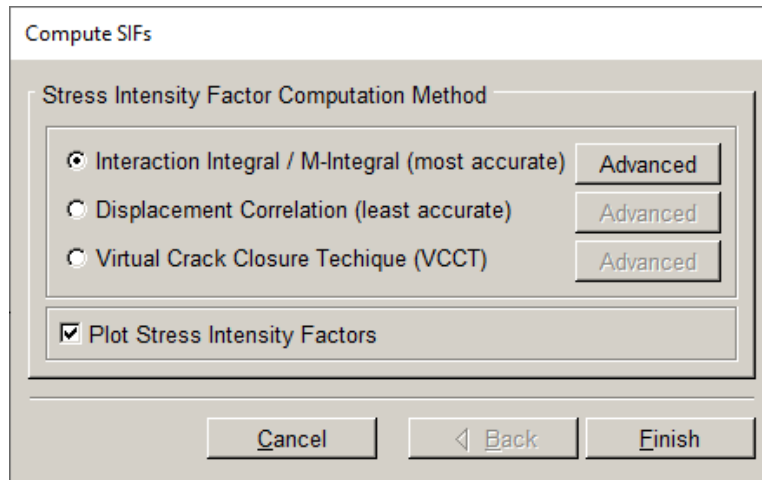

Figure 2.38 Compute SIFs dialog.

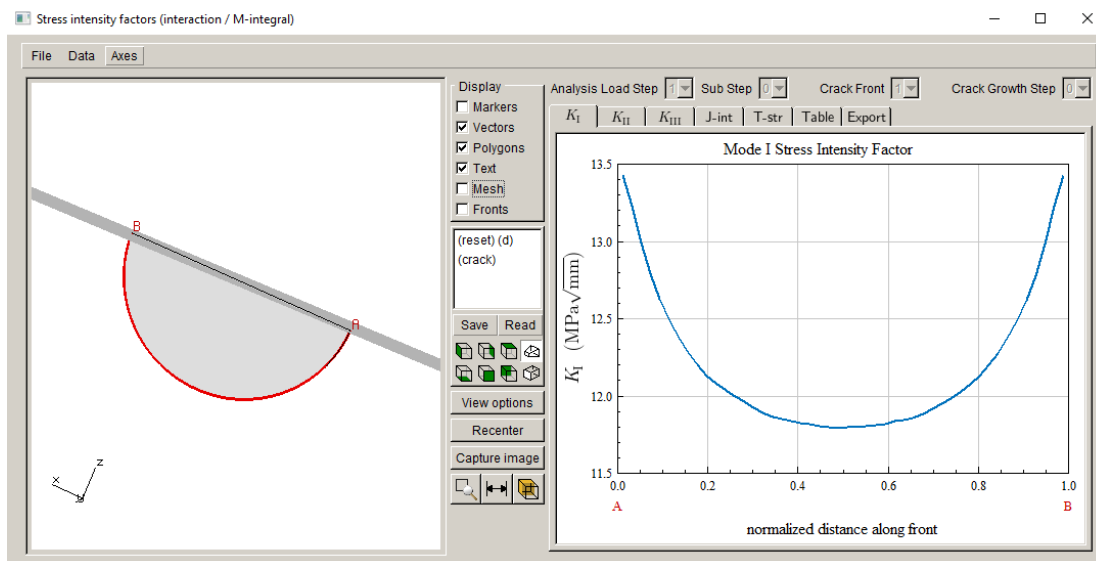

Figure 2.39 Stress Intensity Factor display

## 2.7 Step 7: Manual Crack Growth

We will “manually” propagate the crack front; this lets us examine the predicted crack growth to determine suitable parameters for fitting and extrapolation before proceeding with automated crack growth, which is described in Section 2.8.

### Step 7.1: Select Grow Crack

From the FRANC3D menu, select **Cracks** → **Grow Crack**, Fig 2.40. In the first panel, Fig 2.41, switch to Quasi-Static crack growth and select **Next**. Use the Max Tensile Stress theory to determine the kink angle, Fig 2.42; in this model, crack growth is mostly planar. Select **Next**. Use a Power Law relationship to determine relative growth among points along the crack front, Fig 2.43; we will use the default power  $n=2$ . There is only one load step in the model. Select **Finish** to proceed. You will be asked if you want to save the growth parameters to a file, Fig 2.44, you can select **No**.

This quasi-static growth model can be considered a simplified Paris model; it is simpler to use than the subcritical growth model. Consult the Reference document for descriptions of crack extension models.

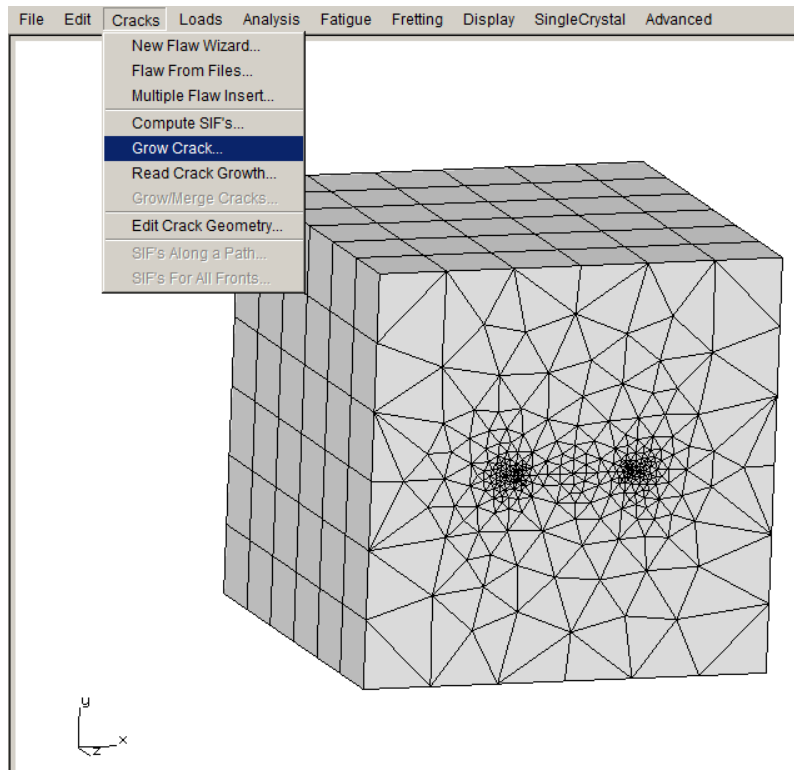

Figure 2.40 Grow Crack menu option.

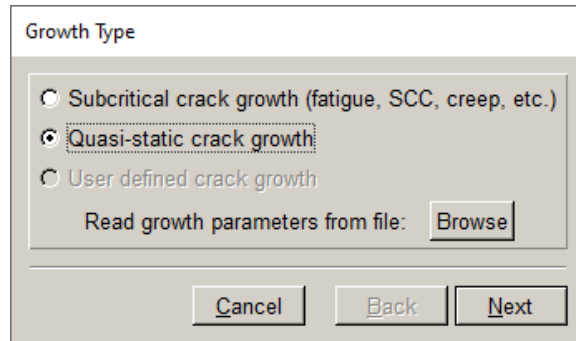

Figure 2.41 Crack Growth wizard – first panel.

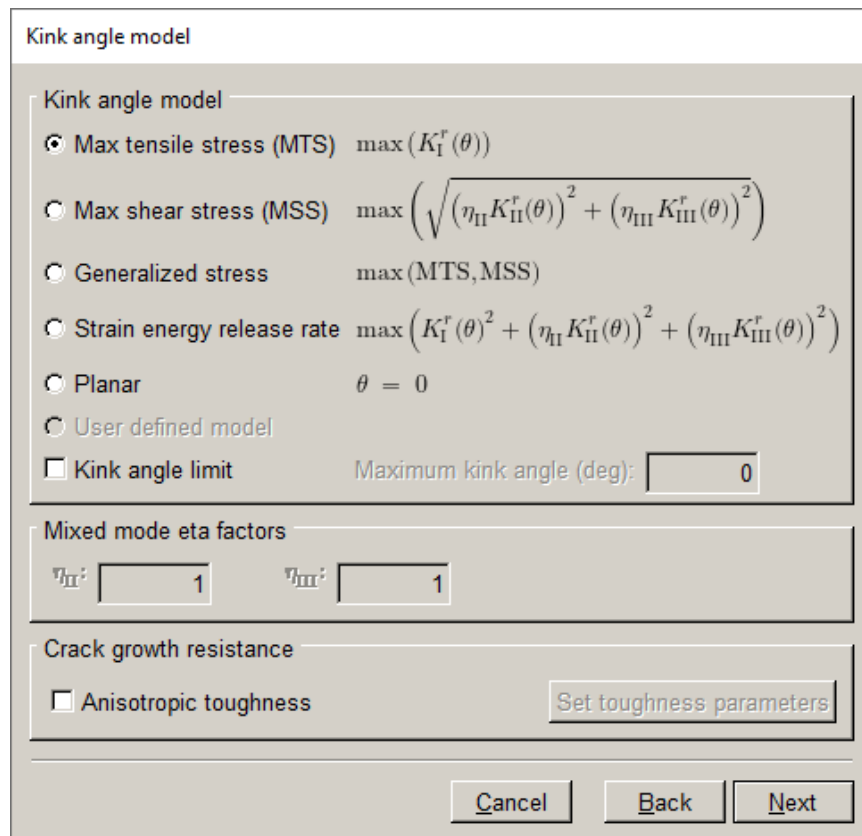

Figure 2.42 Crack Growth wizard – second panel using quasi-static growth.

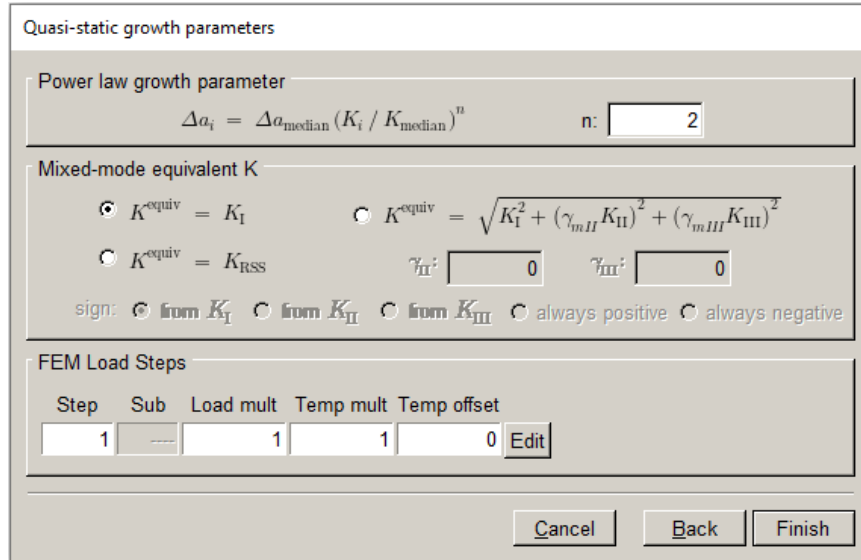

Figure 2.43 Crack Growth wizard – third panel using quasi-static growth.

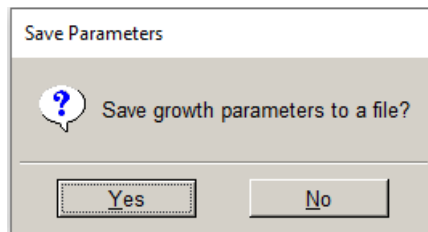

Figure 2.44 Save growth parameters dialog.

### Step 7.2: Specify Fitting and Extrapolation

The next panel, Fig 2.45, allows you to specify the crack front point fitting parameters. You can double click on the (crack) view to see the crack surface; it should be the default view.

The median extension is set to 0.15; this value usually is set automatically based on the initial template radius, so your value might be different. We change it to 0.12 and turn on Mesh and Markers (top right checkbox in Fig 2.45). The green boxes are the computed new front points, and the blue line is the curve-fit, Fig 2.46. Note that the scale node is 0.5; the computed extensions are sorted from minimum to maximum, and the scale node can vary from 0 to 1. For a scale node of 0.5, the median extension is set to the user-specified value and all other extensions are scaled accordingly.

A Fixed order polynomial with order set to 3 and extrapolation set to 2% at both ends of the crack front is the default; the fitting parameters might need to be adjusted as the crack grows. A 4<sup>th</sup> order polynomial might provide a slightly better fit in this case; the guideline for curve-fitting is to use the simplest fit that is reasonable. The extrapolation is automatically adjusted to make sure the end points of the fitted-front fall outside the model surface. We stick with the default 3<sup>rd</sup> order polynomial; select **Next** to proceed.

Note that the fitted (blue) curve must be extrapolated so that both ends fall outside of the model, but it should not be extrapolated too much. Normally FRANC3D will automatically find reasonable values for extrapolation.

The median extension must be enough to provide finite space between the current and new fronts along the entire front to define new crack geometry. It is best to specify the extension (and have cycles computed) as opposed to specifying the cycles and having extension computed.

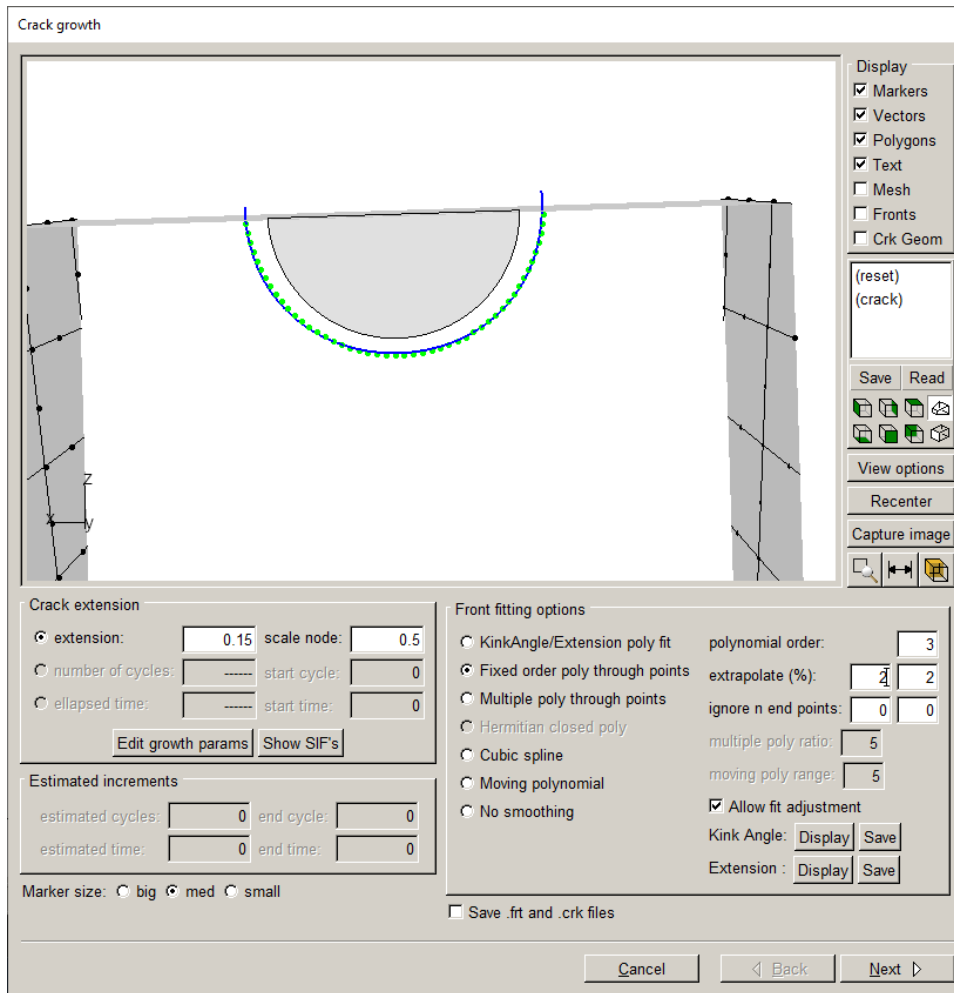

Figure 2.45 Crack growth wizard panel for crack front fitting options

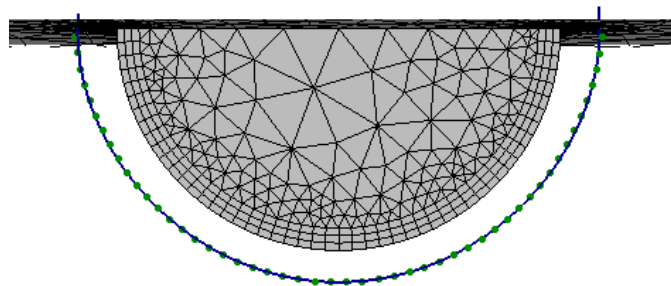

Figure 2.46 Curve fit (blue) through front (green) points.

### Step 7.3: Specify Crack Front Template

The final panel, Fig 2.47, allows you to specify the crack front mesh template parameters. The crack front mesh template extends beyond the model surface, which corresponds with the front-fit extrapolation. The template radius can be set as an absolute value or as a % of the median extension. A relative value of 85% is shown in Fig 2.47; we switch to an absolute value of 0.1, Fig 2.48, which is the same as the initial crack template radius. Select **Next** on this panel when ready to proceed with crack insertion and remeshing.

Note that the crack geometry for the extended crack is inserted into the original uncracked model, so do not overwrite or remove the original uncracked model files.

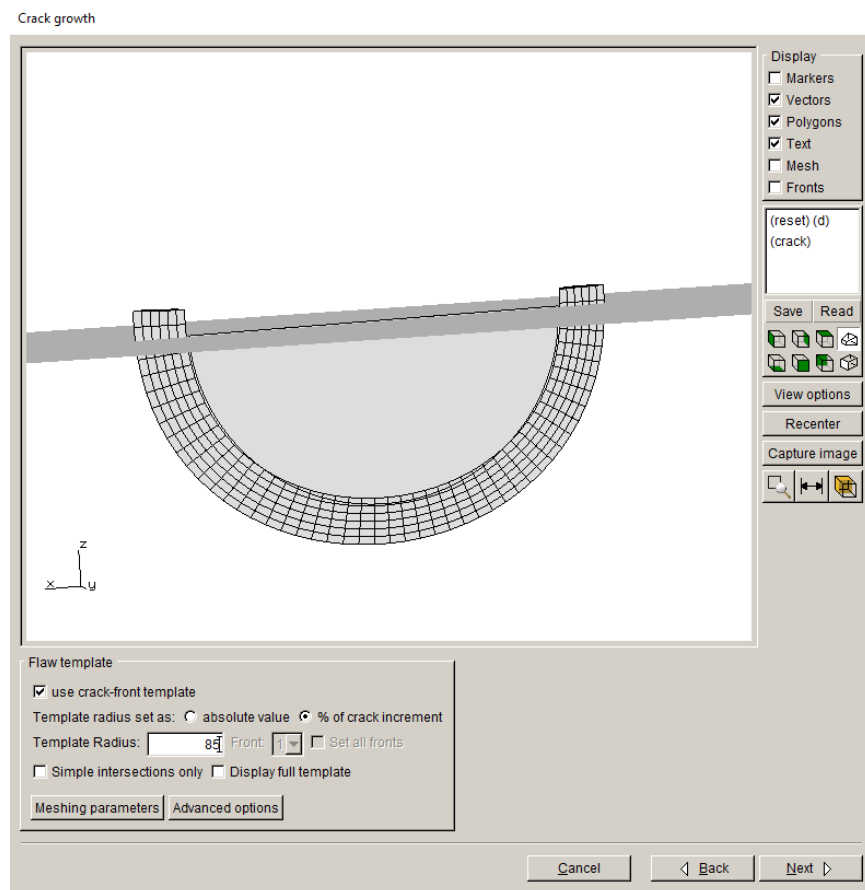

Figure 2.47 Crack growth wizard panel for mesh template options

A template radius that is slightly less than the crack extension usually works best, especially for cases where there is kinking or turning of the crack front.

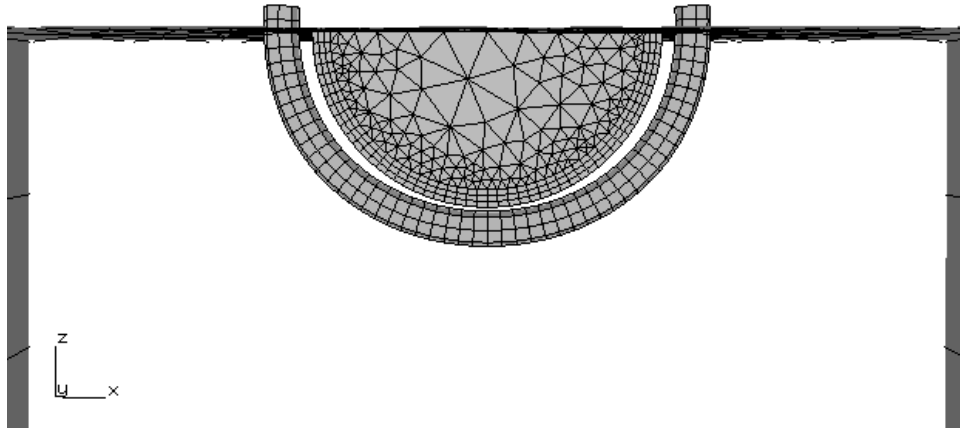

Figure 2.48 Template radius set to 0.1.

The resulting model can be analyzed as was done for the initial crack (see Step 5 above). Note that you will want to give this model a different name, such as *Sierra\_Cube\_step\_001*, so that you do not overwrite the initial crack files. You could continue with manual steps of growth followed by static analysis, or you can try automated crack growth, which is described next.

## 2.8 Step 8: Automatic Crack Growth

This section describes the steps for automatic crack growth starting from the initial crack model. We start with the existing FRANC3D model, using the model created in Sections 2.4 and 2.5. In most cases, we would simply do automatic growth after the manual step described in Section 2.7, but this will not show all the dialogs, so we restart from the initial crack model.

### *Step 8.1: Open FRANC3D Restart File*

Start with the FRANC3D graphical user interface (see Fig 1.1) and select **File** → **Open**. Select the file name specified in Section 2.5, called *Sierra\_Cube\_Subdivide.fdb*. Select **Accept**. The



model is read into FRANC3D (along with the results that were created when running the static analysis). We will ignore the fact that we already propagated the initial crack in the previous step (but we will use the settings). The next section describes the steps for automatic crack growth analysis.

### ***Step 8.2: Select Crack Growth Analysis***

From the FRANC3D menu, select **Analysis** → **Crack Growth Analysis**, Fig 2.49. The first panel of the wizard, Fig 2.50, allows you to choose the method for computing SIFs. We use the default M-integral and select **Next**. If this panel does not show up, the SIF method is chosen automatically based on your earlier choice when plotting SIFs.

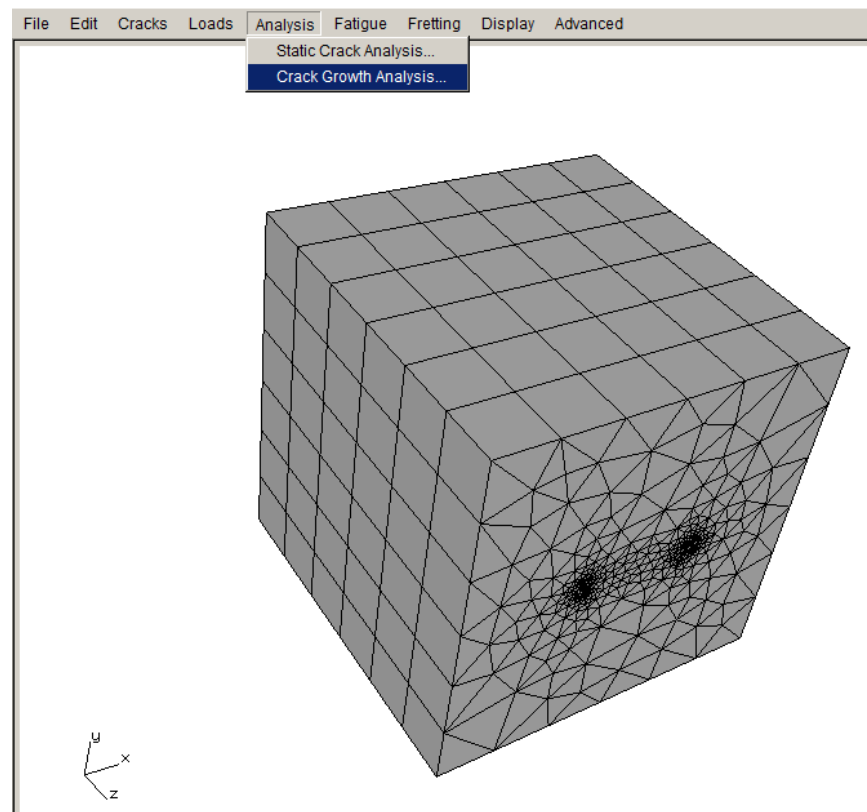

Figure 2.49 Crack Growth Analysis menu

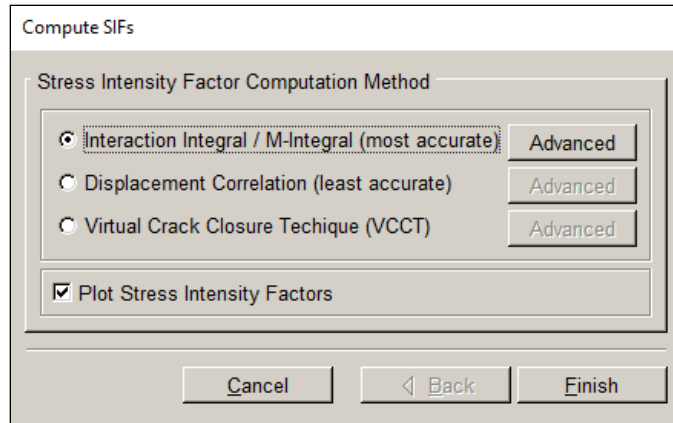

Figure 2.50 Crack Growth Analysis wizard – first panel.

### ***Step 8.3: Specify Growth Rules***

The second panel, Fig 2.51, lets us set the crack growth type; we use quasi-static growth. Select **Next** to display the third panel, Fig 2.52; use the default MTS theory to compute the kink angle. Select **Next** to display the fourth panel, Fig 2.53; use the default settings for the quasi-static growth; there is only one FEM load step to select. Select **Next**. You will be asked if you want to save the growth parameters to a file; you can select **No**.

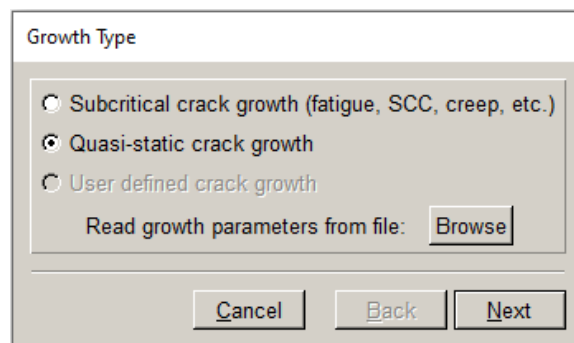

Figure 2.51 Crack Growth Analysis wizard – second panel.

Kink angle model

Kink angle model

Max tensile stress (MTS)  $\max(K_I^r(\theta))$   
 Max shear stress (MSS)  $\max\left(\sqrt{(\eta_{II}K_{II}^r(\theta))^2 + (\eta_{III}K_{III}^r(\theta))^2}\right)$   
 Generalized stress  $\max(\text{MTS}, \text{MSS})$   
 Strain energy release rate  $\max\left(K_I^r(\theta)^2 + (\eta_{II}K_{II}^r(\theta))^2 + (\eta_{III}K_{III}^r(\theta))^2\right)$   
 Planar  $\theta = 0$   
 User defined model  
 Kink angle limit Maximum kink angle (deg):

Mixed mode eta factors

$\eta_{II}$ :       $\eta_{III}$ :

Crack growth resistance

Anisotropic toughness

Figure 2.52 Crack Growth Analysis wizard – third panel.

Quasi-static growth parameters

Power law growth parameter

$\Delta a_i = \Delta a_{\text{median}} (K_i / K_{\text{median}})^n$      n:

Mixed-mode equivalent K

$K^{\text{equiv}} = K_I$        $K^{\text{equiv}} = \sqrt{K_I^2 + (\gamma_{mII}K_{II})^2 + (\gamma_{mIII}K_{III})^2}$   
  $K^{\text{equiv}} = K_{\text{RSS}}$       $\gamma_{II}$ :       $\gamma_{III}$ :

sign:  from  $K_I$     from  $K_{II}$     from  $K_{III}$     always positive    always negative

FEM Load Steps

Step	Sub	Load mult	Temp mult	Temp offset
<input type="text" value="1"/>	<input text"="" type="text" value="1"/>	<input type="text" value="1"/>	<input type="text" value="0"/> <input type="button" value="Edit"/>	

Figure 2.53 Crack Growth Analysis wizard – fourth panel.

#### Step 8.4: Specify Fitting and Template Parameters

The fifth panel, Fig 2.54, lets us set the crack front fitting and mesh template parameters. Use the default 3<sup>rd</sup> order polynomial and 2% extrapolation. Set the template radius to an absolute value of 0.1. Select **Next**.

**Fitting & Template Parameters**

**Front Fitting Options**

- KinkAngle/Extension Poly Fit
- Fixed Order Poly Through Points
- Multiple Poly Through Points
- Hermitian Closed Poly
- Cubic Spline
- Moving Polynomial
- No Smoothing

polynomial order:

extrapolate (%):

ignore n end points:

multiple poly ratio:

moving poly range:

Allow fit adjustment

**Flaw Template**

use crack-front template

Template radius set as:  absolute value  % of crack increment

Template Radius:  Front:   Set All Fronts

Simple Intersections Only

**Extension**

distance extension scale node:

cycles extension

time extension

Figure 2.54 Crack Growth Analysis wizard – fifth panel.

#### Step 8.5: Specify Growth Plan

The sixth panel, Fig 2.55, lets us define the amount of extension for each step of crack growth. Set the number of steps to five and the constant median extension to 0.2. Select **Next**.

Note that we are taking a fairly large crack growth step; this is to limit the number of steps and time for this tutorial. Large steps can sometimes lead to issues with oscillations in the shape of the crack fronts (see Section 9 of the User’s Guide), but for this model 0.2 is acceptable.

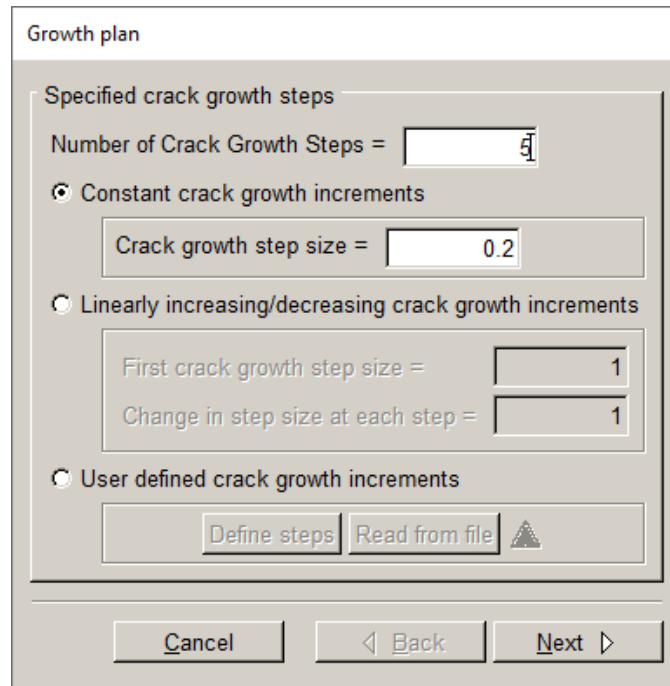

Figure 2.55 Crack Growth Analysis wizard – sixth panel.

### ***Step 8.6: Specify Analysis Code***

The seventh panel, Fig 2.56, shows that SIERRA is the solver. The current crack growth step defaults to 0 – representing the initial crack. (If we “manually” propagated the crack first, we should set this to 1.) FRANC3D will extend the initial crack based on the growth rule defined in the previous panels, and then name the resulting set of files as *Sierra\_Cube\_Subdivide\_STEP\_001.\**. Subsequent file names have the step number incremented as the automatic analysis proceeds. Select **Next** (button not shown in Fig 2.56).

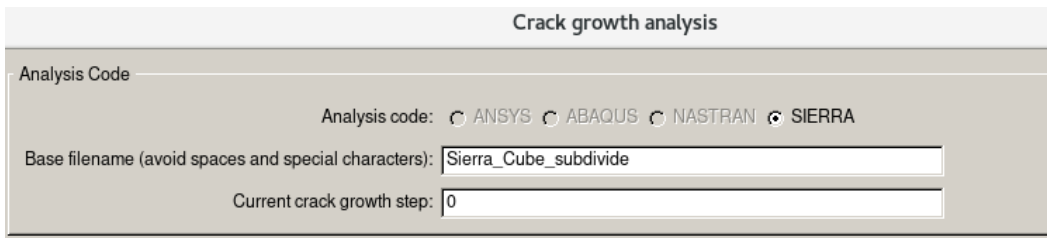

Figure 2.56 Crack Growth Analysis wizard – seventh panel.

The eighth panel, Fig 2.57, shows the analysis settings. You should have already set the SIERRA executable path in the FRANC3D Preferences. The Global model settings should be set automatically. Select **Finish**.

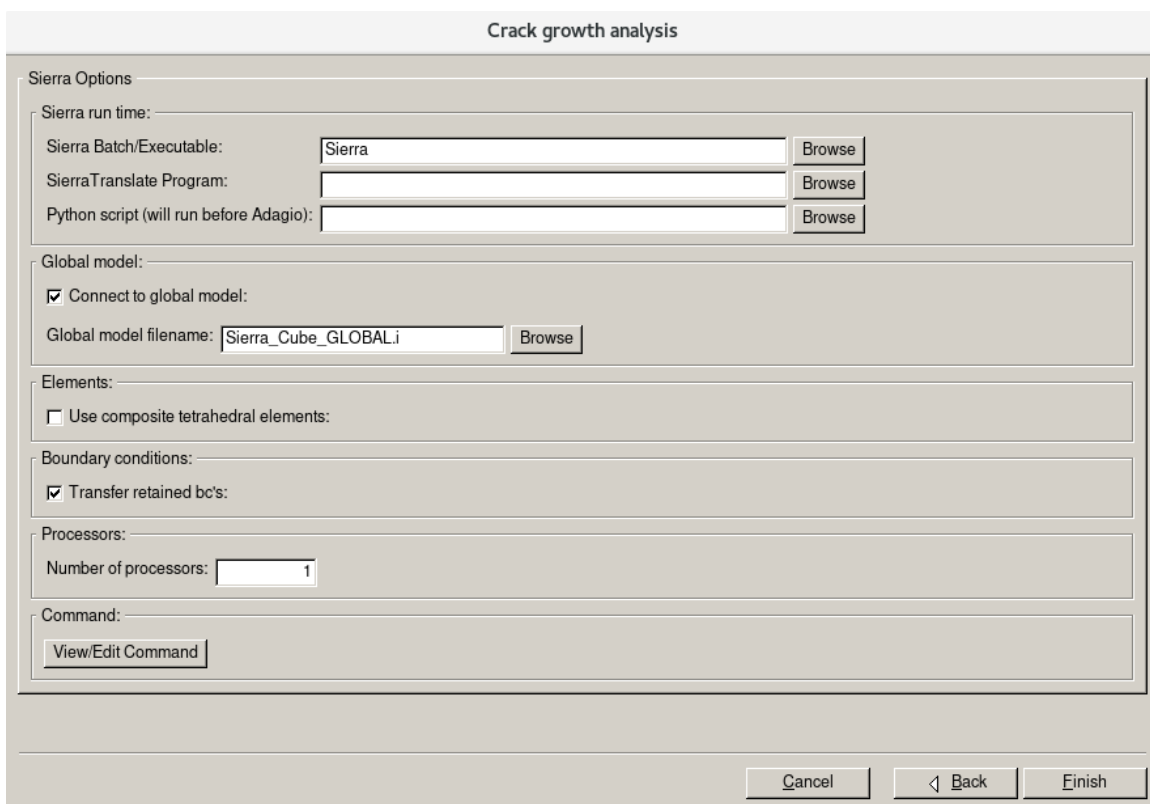

Figure 2.57 Crack Growth Analysis wizard – eighth panel.

FRANC3D extends the initial crack first. It then saves *.fdb*, *.i* and other files for the first crack step model, using the name *Sierra\_Cube\_Subdivide\_STEP\_001*, and then SIERRA starts in the background. If the analysis stops at any stage, it can be restarted from the last successful crack step. All the required restart *\_STEP\_#* files are retained. The model for any step can be read into FRANC3D to view the SIFs or to restart the analysis with a modified crack growth increment or modified fitting (for example).

A summary of the various files can be found in Section 3 of the User's Guide.

## 2.9 Step 9: SIF History and Fatigue Life

Once the automatic crack growth analysis from Step 8 has finished, the SIF history can be displayed. If you still have FRANC3D open and the crack growth from Step 8 is done, you can proceed with Step 9.1. Otherwise, you can restart FRANC3D and read in the *.fdb* file for the last step, using the **File** → **Open** menu option.

### *Step 9.1: Select SIFs Along a Path*

From the FRANC3D menu, select **Cracks** → **SIFs Along a Path**, Fig 2.58. If the SIFs have not been computed yet, the Compute SIFs dialog (see Fig 2.50) will be displayed; leave the defaults and select **Finish**.

The Stress Intensity Factors (along a path) dialog should appear, Fig 2.59. The crack fronts are displayed on the left along with the path through the fronts; the SIF history along the path is shown in the graph on the right. You can use the tabs above the graph to plot the Mode II and III SIFs as well as the elastic J-integral and T-stress values along the path. You can define a new path, Fig 2.60. You can export the data also; for example, you might need to export the Mode I SIF history (K vs a) to compute fatigue cycles using a different program. The exported data files are ASCII txt files.

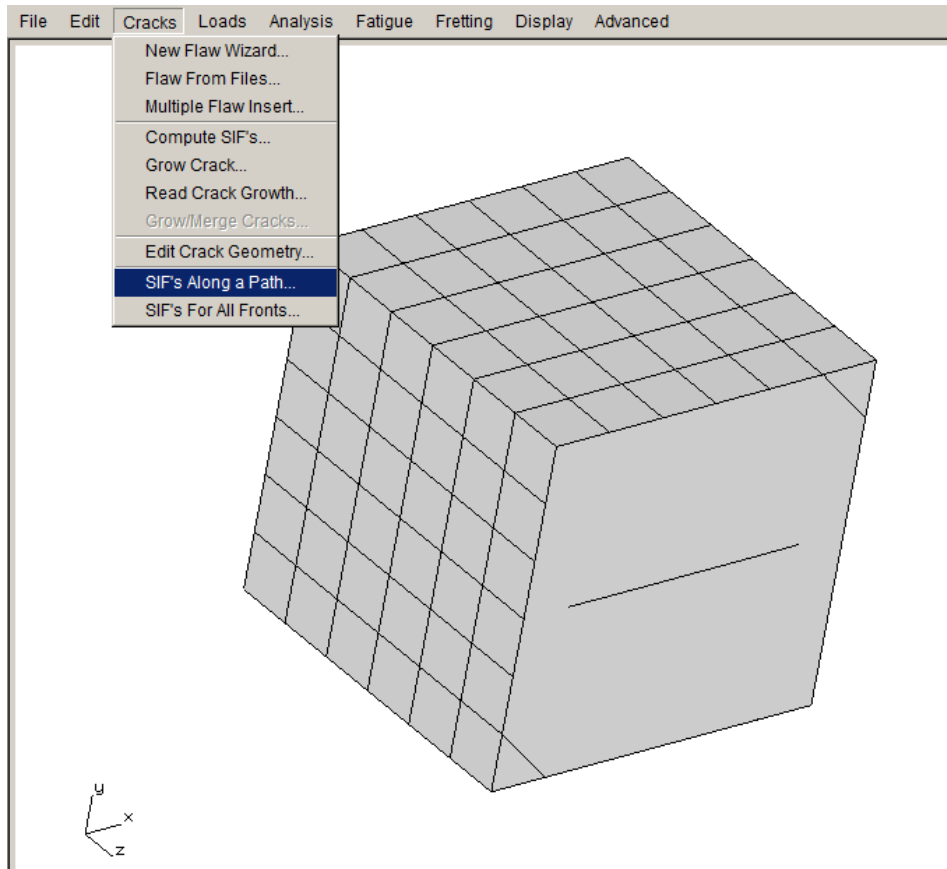

Figure 2.58 SIFs Along a Path menu option

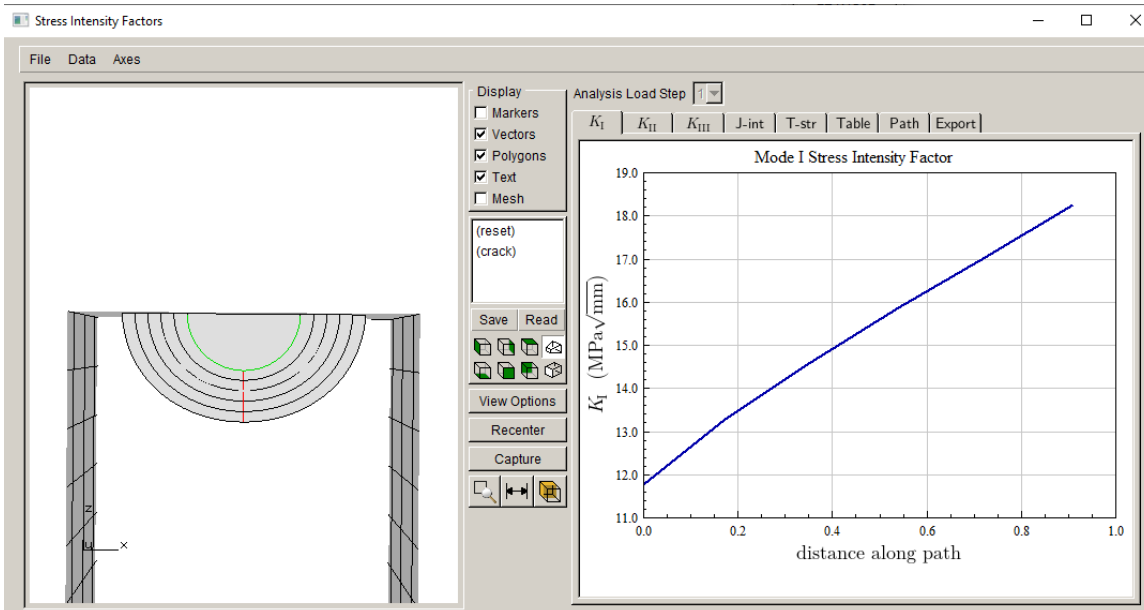

Figure 2.59 SIFs Along a Path dialog – KI plot



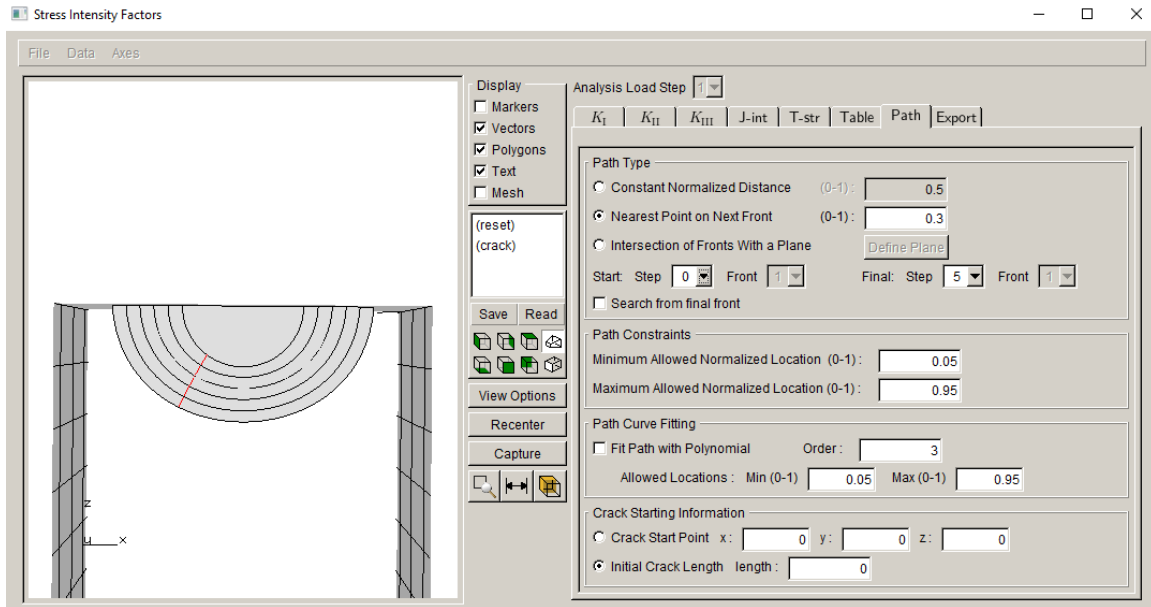

Figure 2.60 SIFs Along a Path dialog – Define Path

### ***Step 9.2: Select SIFs For All Fronts***

From the FRANC3D menu, select **Cracks** → **SIFs For All Fronts**. If the SIFs have not been computed yet, the Compute SIFs dialog will be displayed; leave the defaults and select **Finish**.

The Stress Intensity Factors (for all fronts) dialog should appear, Fig 2.61. The crack fronts are displayed on the left, and the SIFs for all crack fronts are displayed on the right. You can use the tabs above the plot to display Mode II and III SIFs as well as the elastic J-integral and T-stress values. If there are multiple crack fronts or multiple load steps, these can be selected using the drop-down lists; this will be seen in subsequent tutorials.

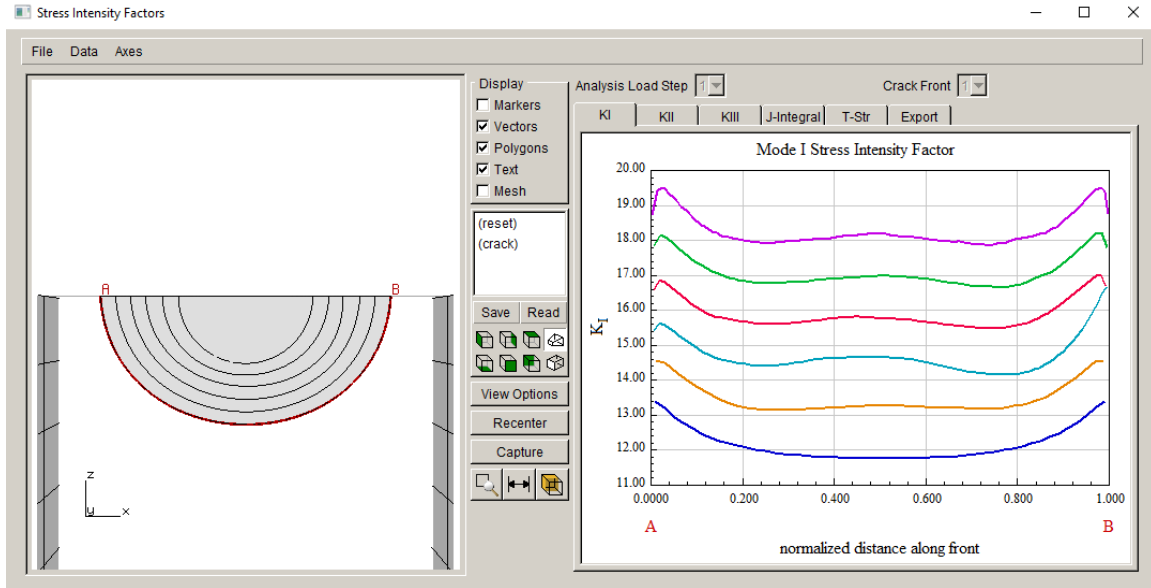

Figure 2.61 SIFs for all Fronts dialog – KI plot

### Step 9.3: Select Fatigue Life Predictions

Fatigue life or cycles can be computed next. From the FRANC3D menu, select **Fatigue** → **Fatigue Life Predictions**, Fig 2.62. If the SIFs have not been computed yet, the Compute SIFs dialog will be displayed; leave the defaults and select **Finish**.

The Fatigue Life dialog should appear as in Fig 2.63. The crack fronts are displayed on the left and the window on the right side should be blank (assuming that lifing parameters have not been defined previously). You must **Set (or Read) Parameters**. Selecting **Set Parameters** displays the dialog shown in Fig 2.64.

The units are MPa and mm; select the **Change** button to display the dialog in Fig 2.65 and set the units to MPa and mm; select **Accept**.

The FEM units can also be set in the main FRANC3D window using the **Edit** menu.

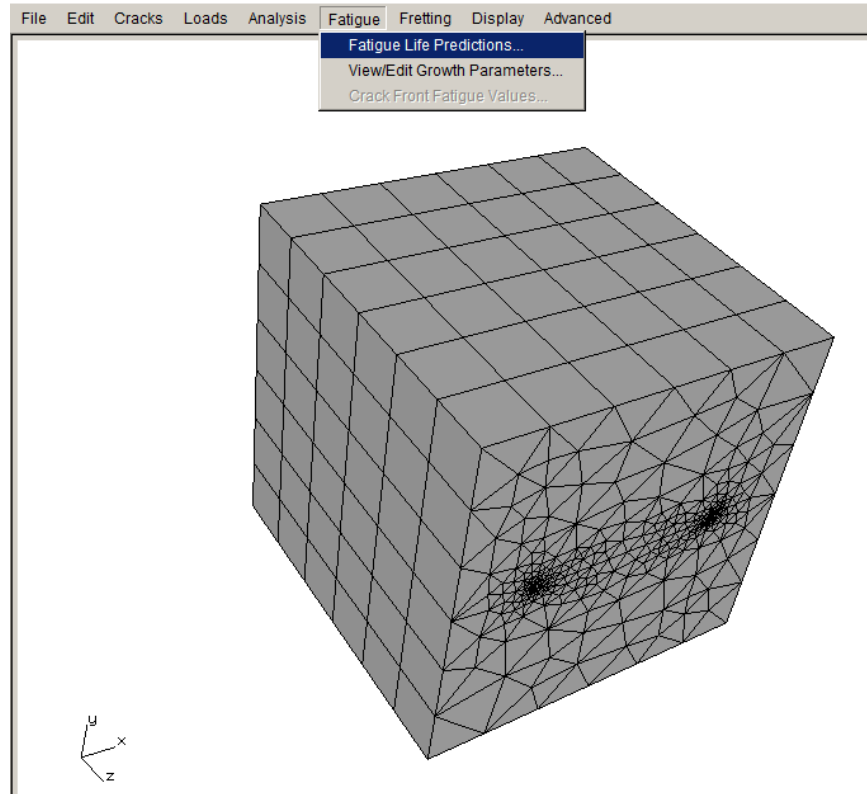

Figure 2.62 Fatigue Life Predictions menu option

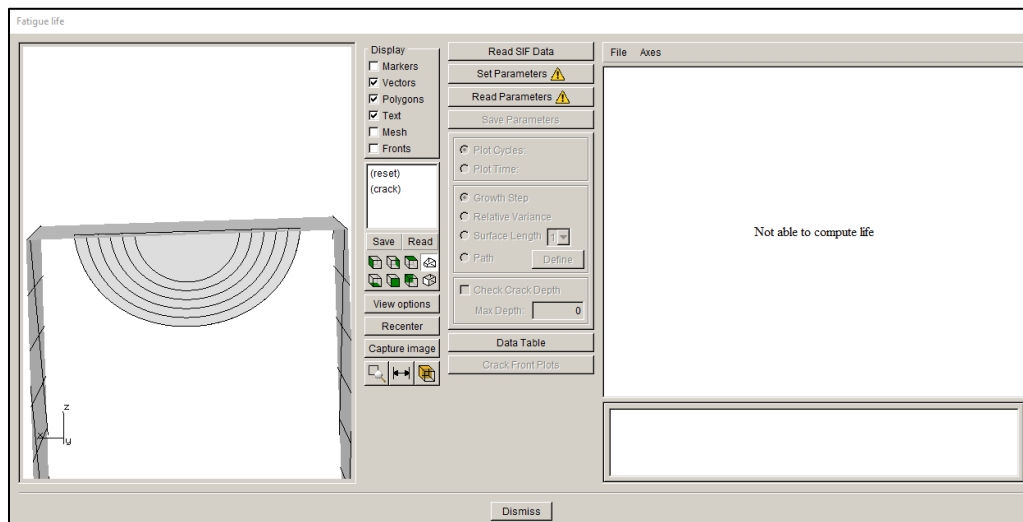

Figure 2.63 Fatigue Life dialog

Growth Parameters

Units used in FE model  
 stress: MPa length: mm temp: C time: sec Change

**Crack growth load schedule**

New schedule Read from file Wizard View/Edit Save to file

**Crack growth rate model**

New model Read from file View/Edit da/dN View/Edit da/dt Save to file

Mixed-mode equivalent K

$K^{equiv} = K_I$      
   $K^{equiv} = \sqrt{K_I^2 + (\gamma_{II} K_{II})^2 + (\gamma_{III} K_{III})^2}$   
  $K^{equiv} = K_{RSS}$      
  $\gamma_{II}$ :        $\gamma_{III}$ :   
 sign:  from  $K_I$   
  from  $K_{II}$   
  from  $K_{III}$   
  always positive  
  always negative

Effective delta K

$\Delta K_{eff} = K_{max} - K_{min}$      
   $\Delta K_{eff} = K_{max} - \max(K_{min}, 0)$   
 Use load interaction model Set/Edit parameters

Integration options

Accelerated counting     
  Constant K for time integration

Dynamic pairing metric

$\Delta K_{eff}^{equiv}$      
  $da/dN$      
 Simplified HCF/LCF pairing

Cancel Accept

Figure 2.64 Fatigue Life parameters

Units

label

SI units  
 Length:  mm  m  other  
 Stress:  MPa  Pa  other  
 Temperature:  C  K  other

US customary units  
 Length:  inch  other  
 Stress:  psi  ksi  other  
 Temperature:  F  other

Units of time:

sec  min  hour  day  year  other

Cancel Accept

Figure 2.65 FEM units dialog

The crack growth load schedule is defined next. Select the **New Schedule** button (see Fig 2.64) to display the dialog in Fig 2.66. Select the Schedule and then select the **Add** button; see right side image of Fig 2.66. This will display the dialog shown in Fig 2.67; we use a simple cyclic load schedule where the applied load produces  $K_{max}$ , and  $K_{min}$  is zero. Select **Accept** to return to the Load Schedule, Fig 2.68.

The stress ratio is set to 0.0. There is only one load case, which represents the  $K_{max}$  condition. The Repeat count is set to FOREVER. Select **Accept** to finish the load schedule. There is only one event in the schedule so the repeat forever can be set for either the event or the schedule; it is usually best to set Repeat FOREVER for the schedule.

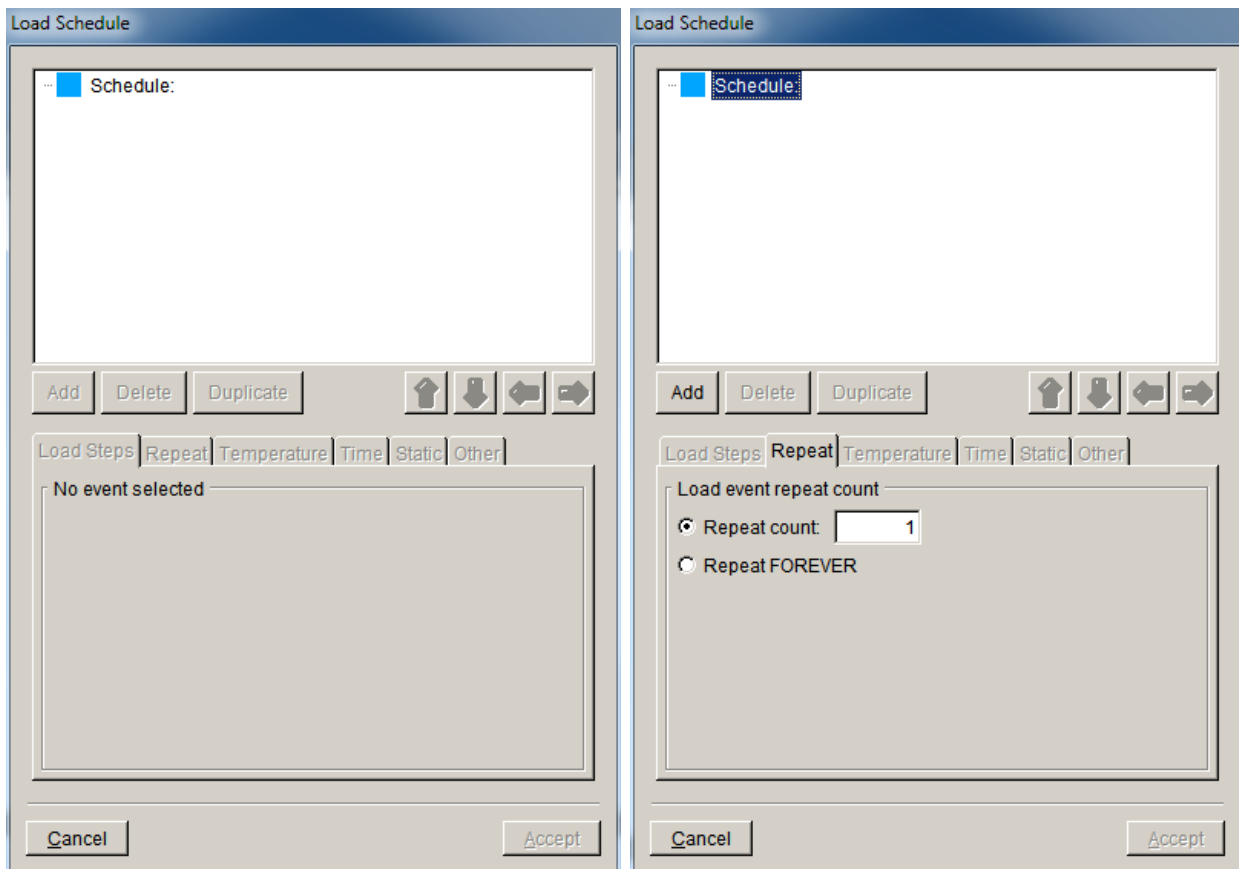

Figure 2.66 New Load Schedule dialog



Figure 2.67 Event type dialog

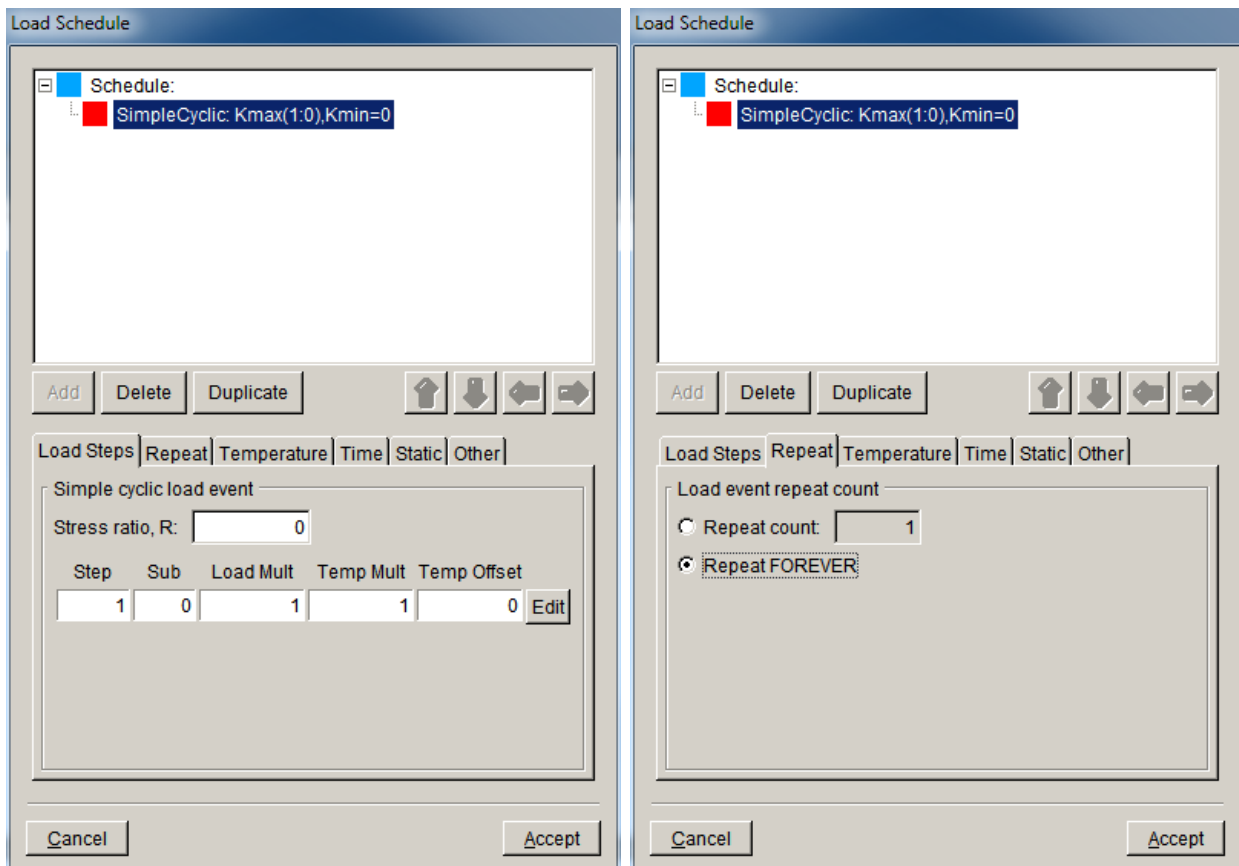

Figure 2.68 Simple cyclic load schedule repeated forever

The crack growth rate model is defined next. Select the **New Model** button (see Fig 2.64) to display the dialog in Fig 2.69. Choose the cyclic loading growth rate model, and select **Next** to display the dialog in Fig 2.70.

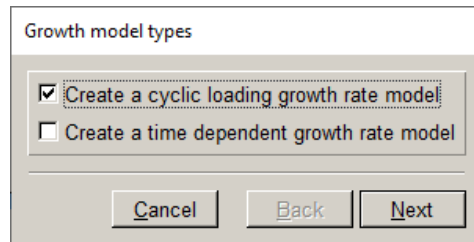

Figure 2.69 Growth model type dialog

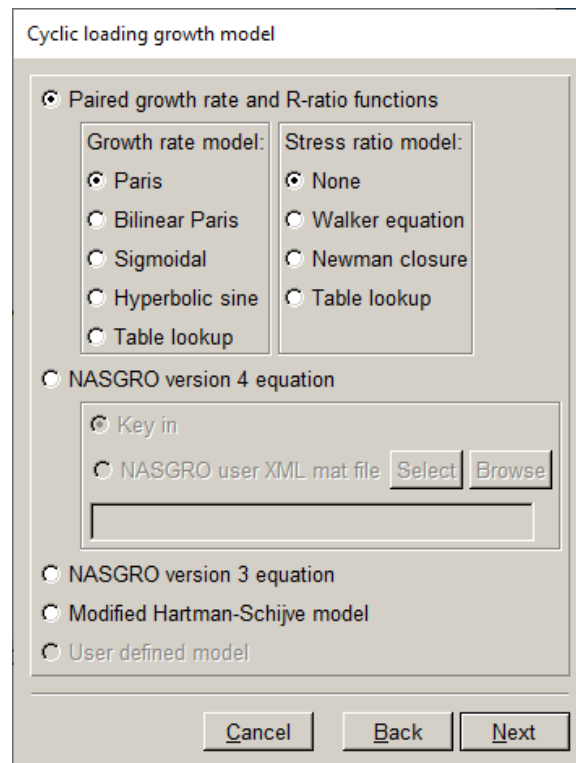

Figure 2.70 Cyclic loading growth model dialog

We use a Paris growth model, which is the default; select **Next** to display the dialog in Fig 2.71. The growth rate model will be temperature independent. Select **Next** to display the Paris growth model dialog, Fig 2.72.

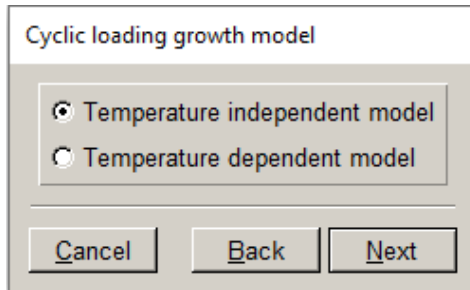

Figure 2.71 Temperature dependent or independent growth rate model dialog

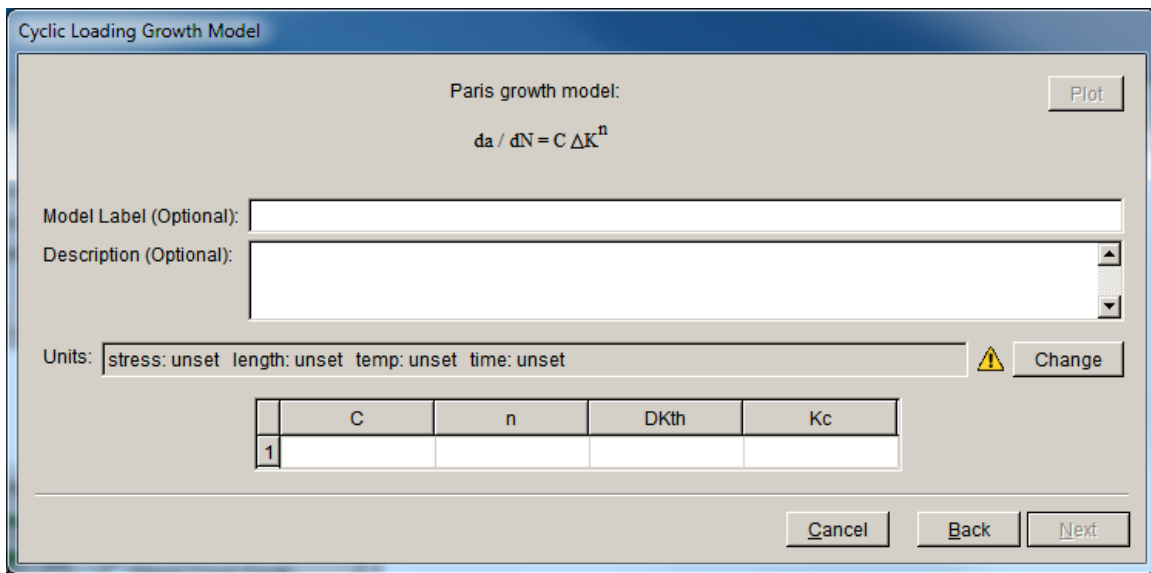

Figure 2.72 Paris growth rate model dialog

First, set the units for the Paris growth model. Select the **Change** button to display the Units dialog, Fig 2.73. Set the units the same as the FEM units that we set earlier, which were MPa and mm. If your growth model units are different from the FEM units, FRANC3D will do the unit conversions automatically. Select **Accept**.



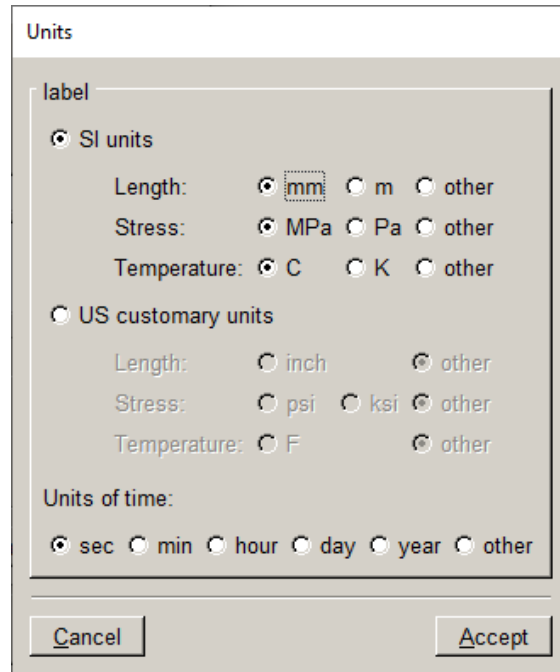

Figure 2.73 Paris growth rate model units

In the Paris growth model dialog, click on the fields for C, n, DKth and Kc and enter the values shown in Fig 2.74. Select **Next** to return to the main dialog (see Fig 2.64). Other options are left at their default values; select **Accept** (Fig 2.64) to return to the Fatigue Life dialog, Fig 2.75.

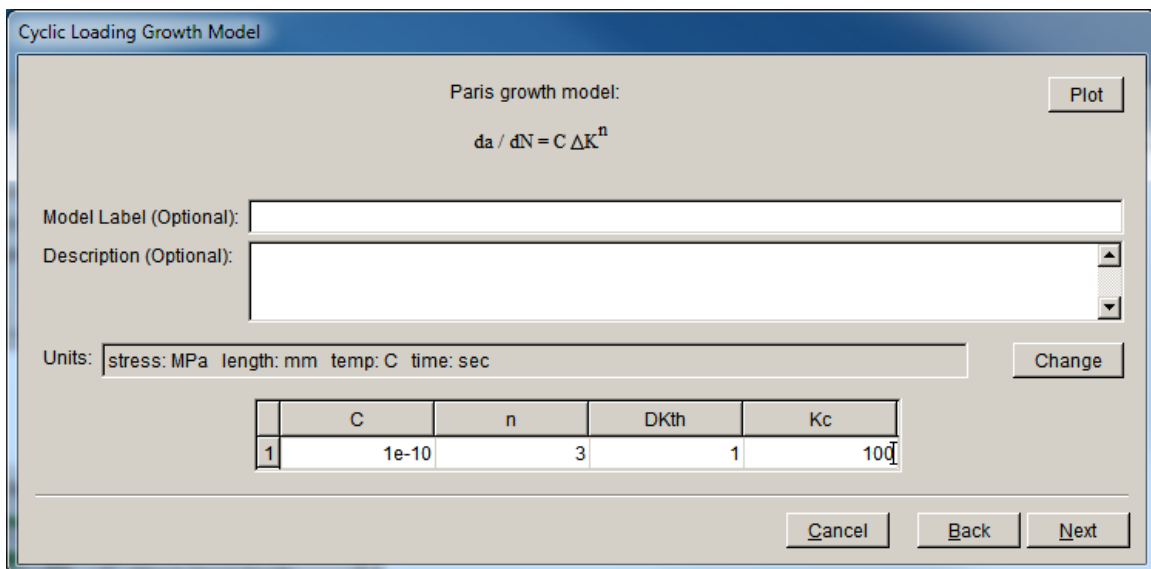

Figure 2.74 Paris growth rate model values

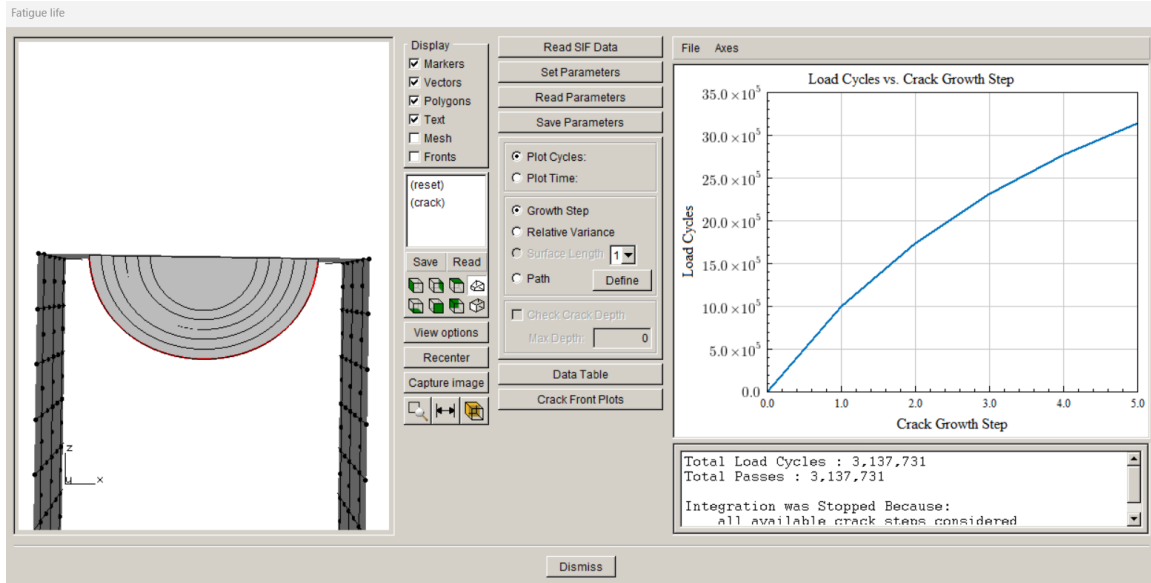

Figure 2.75 Fatigue life dialog showing Cycles vs Crack Growth Step

Note that the Paris exponent ' $n$ ' is set to 3 whereas we used  $n=2$  for the quasi-static growth. In practice, you can use the “correct” fatigue model and material data during the growth, so that growth is consistent with the fatigue life computations done here. However, it is not strictly necessary as fatigue cycles are recomputed here.

If we choose to plot cycles based on a path, we must select the Path radio button and then the **Define** button to create a path, Fig 2.76. The default path is through the crack front midpoints. Once a path is defined, the cycles versus crack path length is displayed, Fig 2.77.

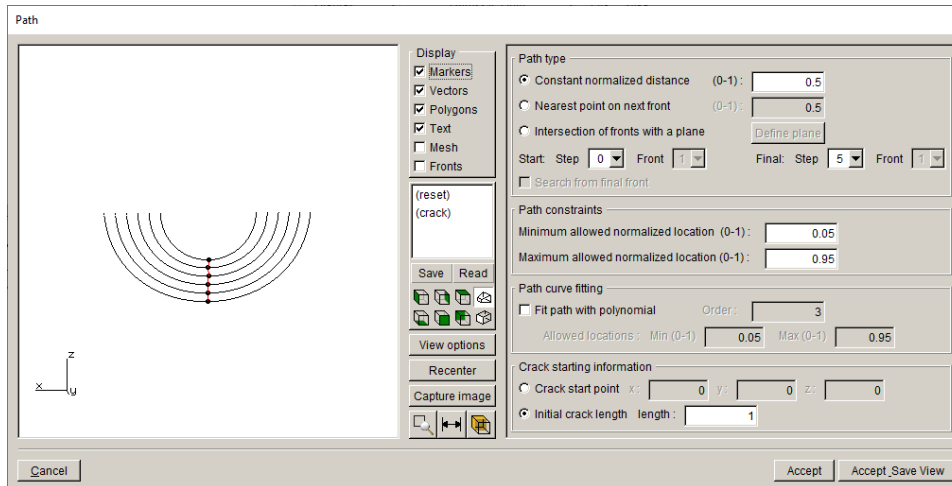

Figure 2.76 Define crack path dialog

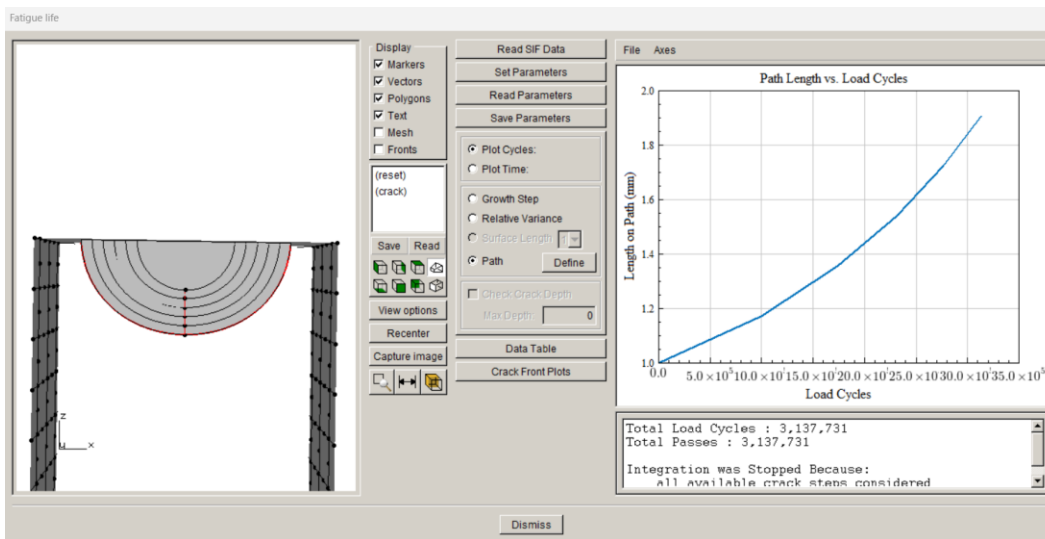

Figure 2.77 Fatigue cycles versus crack length

## 2.10 Step 10: Resume Growth with Larger Submodel

We assume that you used the (local) submodel for the automatic crack growth simulation. If crack growth should exceed the boundary of the local submodel, a larger submodel can be selected and crack growth can be continued without having to restart the simulation from the beginning. In this step, we describe the process of extracting the current crack geometry and inserting this crack into a larger portion of the model to resume crack growth.

### ***Step 10.1: Extract and Save Crack Geometry***

The crack geometry information for each step of crack growth is saved in the FRANC3D restart (.fdb) file. The data appears in this block:

```
FLAWSURF
(
VERSION: 5
NUM_SURFS: 763
SURF: 0
  263 264 356
    6.83559456365193    5.00380971299962    9.72712346638146
...
...
  4.73891556707121    5.00420103803897    8.3468309877949
)
```

This data can be copied from the .fdb file and saved to a .crk file, using any text editor. The .crk file can also be saved during a manual growth step using the Save .frt and .crk files option (see Fig 2.45).

We open the *Sierra\_Cube\_subdivide\_STEP\_005.fdb* file, copy the FLAWSURF data, and save it to a .crk file, called *Sierra\_Cube\_step\_5.crk*.

At step 5, the crack is approaching the boundary of the submodel region, Fig 2.78, so we could not have grown the crack much further.

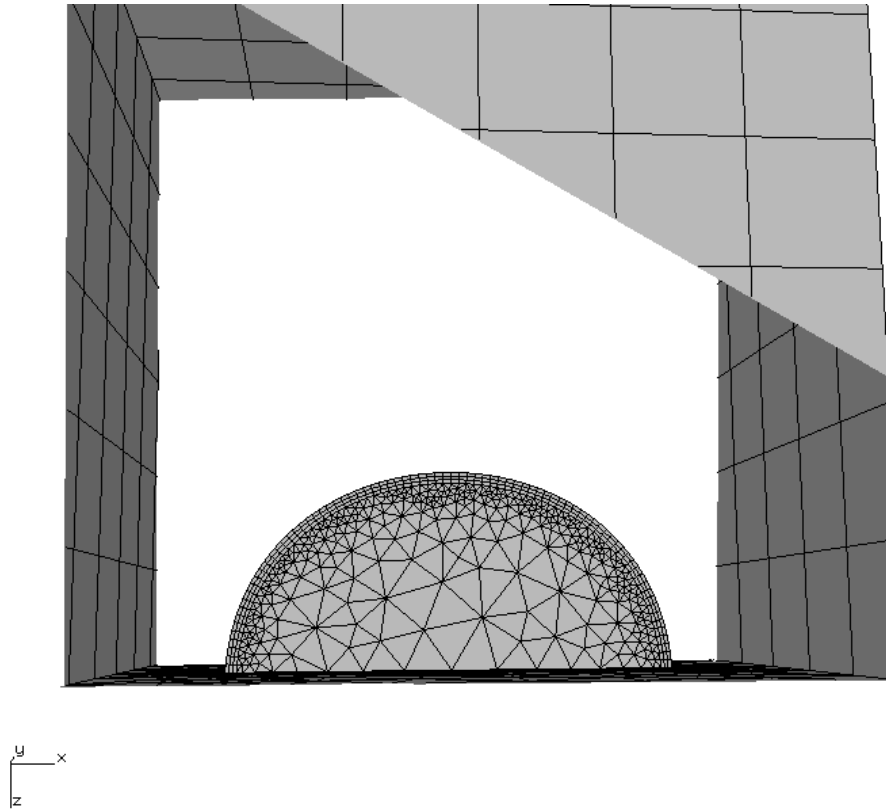

Figure 2.78 Crack step 5 in local submodel.

### ***Step 10.2: Restart from Saved Crack Geometry***

Start FRANC3D, and from the menu select **File** → **Import**. We could extract a larger submodel region from the cube, but for this tutorial, we will just import the full cube model and run subsequent crack growth simulations using the full model.

Select Import a complete model from the dialog, Fig 2.79, set the Mesh File Type to SIERRA, and select the *Sierra\_Cube.i* file, Fig 2.80. Select **Accept** to continue.

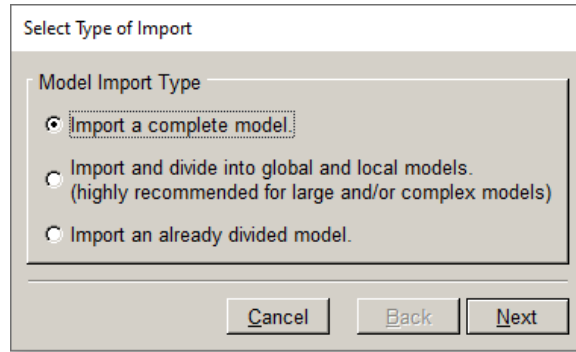

Figure 2.79 FRAN3D model import dialog.

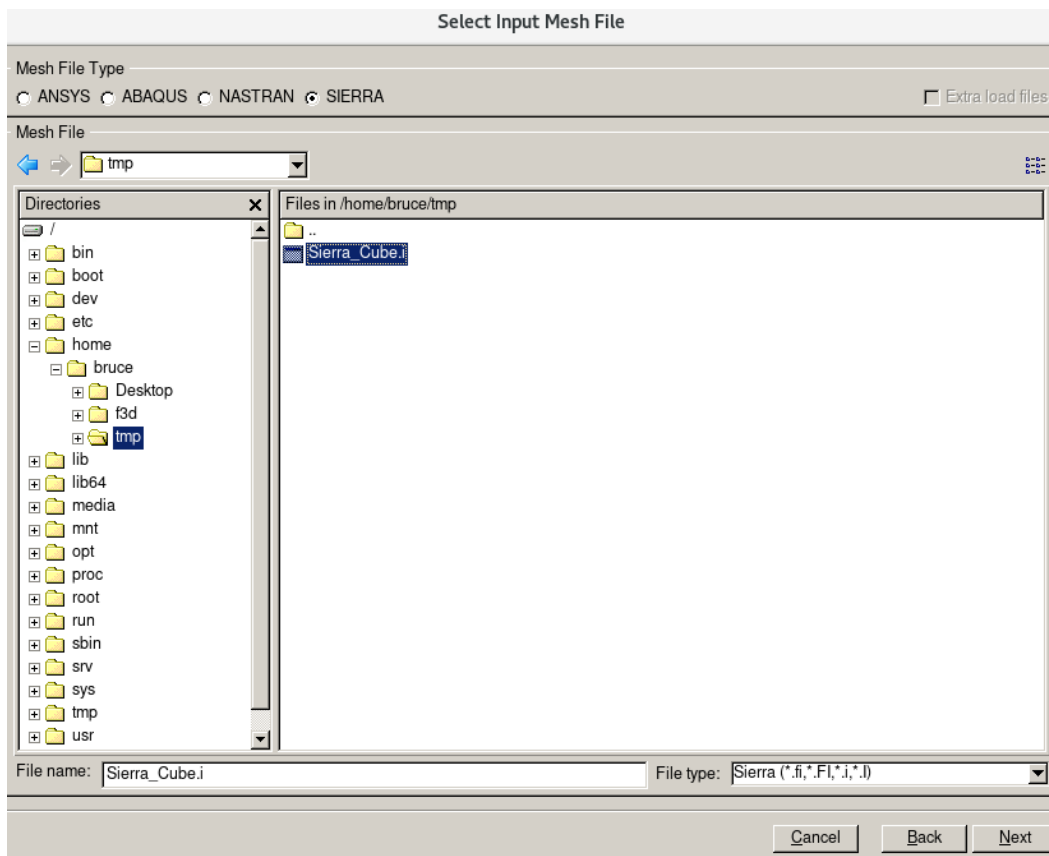

Figure 2.80 FRAN3D mesh import file selector.

Note: if you choose to create a larger local submodel instead of using the full model, make sure you edit the local and global file names so that you do not overwrite for the first set of local and global model files (see the dialog in Fig 2.16).

Use the **Select All** button in the next dialog, Fig 2.81, to retain all the mesh facets where boundary conditions are applied. Select **FINISH** when ready; the model will be imported and displayed in the FRANC3D main window (see Fig 2.8). You might need to set/accept the units as well as the work directory.

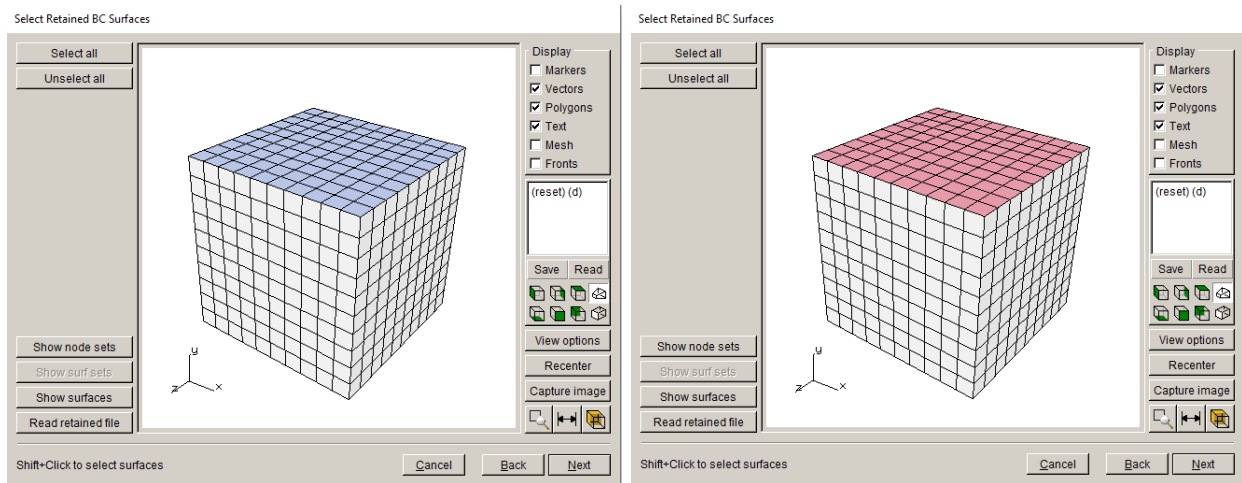

Figure 2.81 Use Select All button to retain all highlighted mesh facets.

From the FRANC3D menu, select **Cracks** and **Flaw From Files**. Select the *Sierra\_Cube\_step\_5.crk* file, which was extracted from the *.fdb* file. The *.crk* file is read and then displayed in the Orient User Flaw dialog, Fig 2.82. Note that the crack geometry includes the original circular crack and all the subsequent steps of growth. Also note that part of the crack geometry falls outside the model (so that intersections can be computed correctly). In general, a crack that is read from a file can be translated in Cartesian space, but for continuing crack growth, we want the exact same location.

Select **Next** to set the mesh template parameters, Fig 2.83; we just use the defaults. Select **Finish** when ready, and the crack will be inserted and the model remeshed.

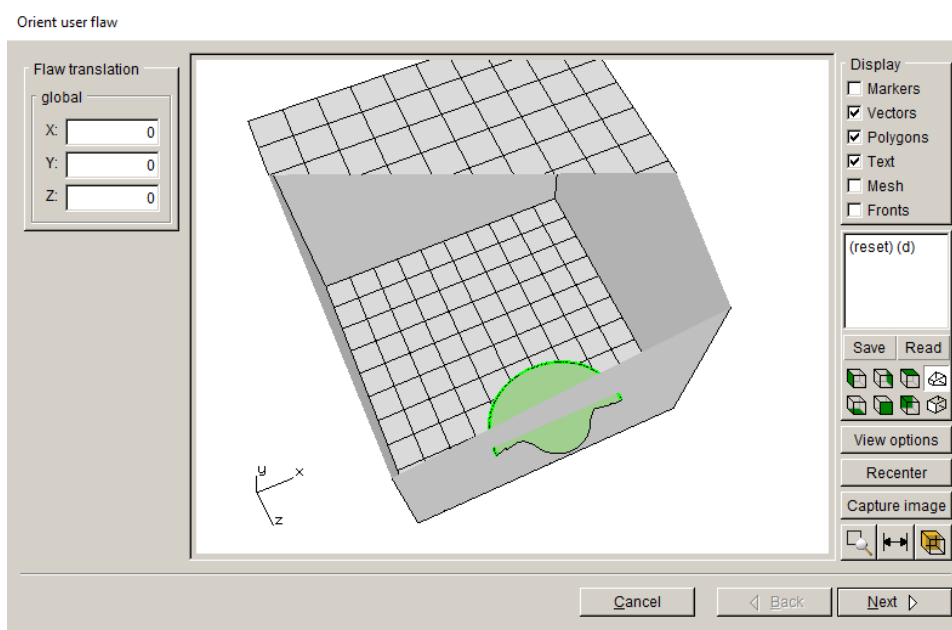

Figure 2.82 Step 5 crack geometry displayed in cube model.

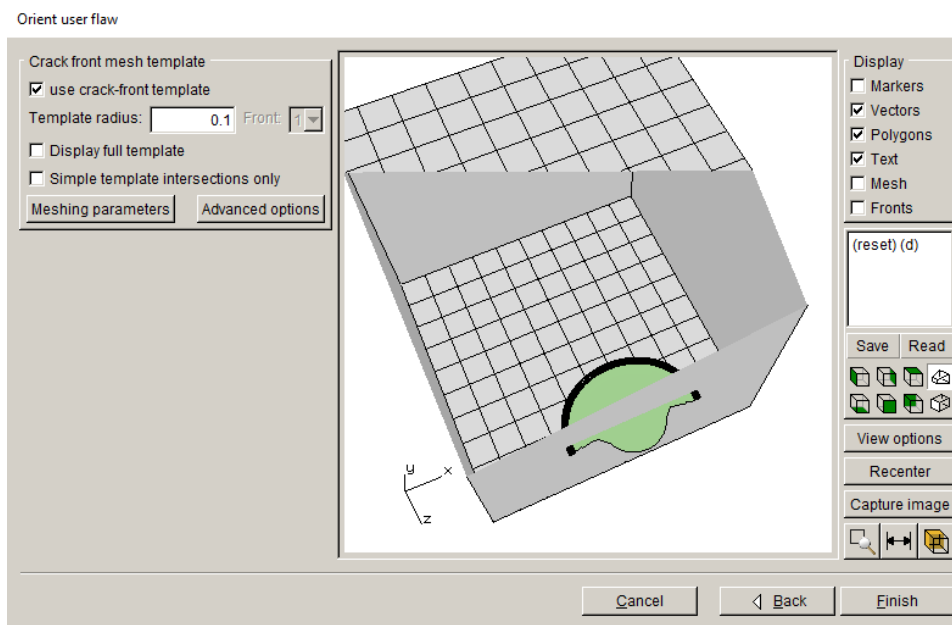

Figure 2.83 Step 5 crack mesh template.

From the FRANC3D menu, select **Static Crack Analysis** and set the analysis parameters; use the same settings as in Step 5. The only thing that changes is the file name so that we do not overwrite the original submodel step files; call it *Sierra\_cube\_full\_STEP\_005*.



The analysis should produce SIFs that are identical to the SIFs computed for the step\_005 using the local submodel region. Fig 2.84 shows the Mode I SIFs for the two cases. There are minor differences as the mesh around the crack front is different. At this stage, the crack can be propagated further; do another six steps of crack growth using the same growth increment of 0.2.

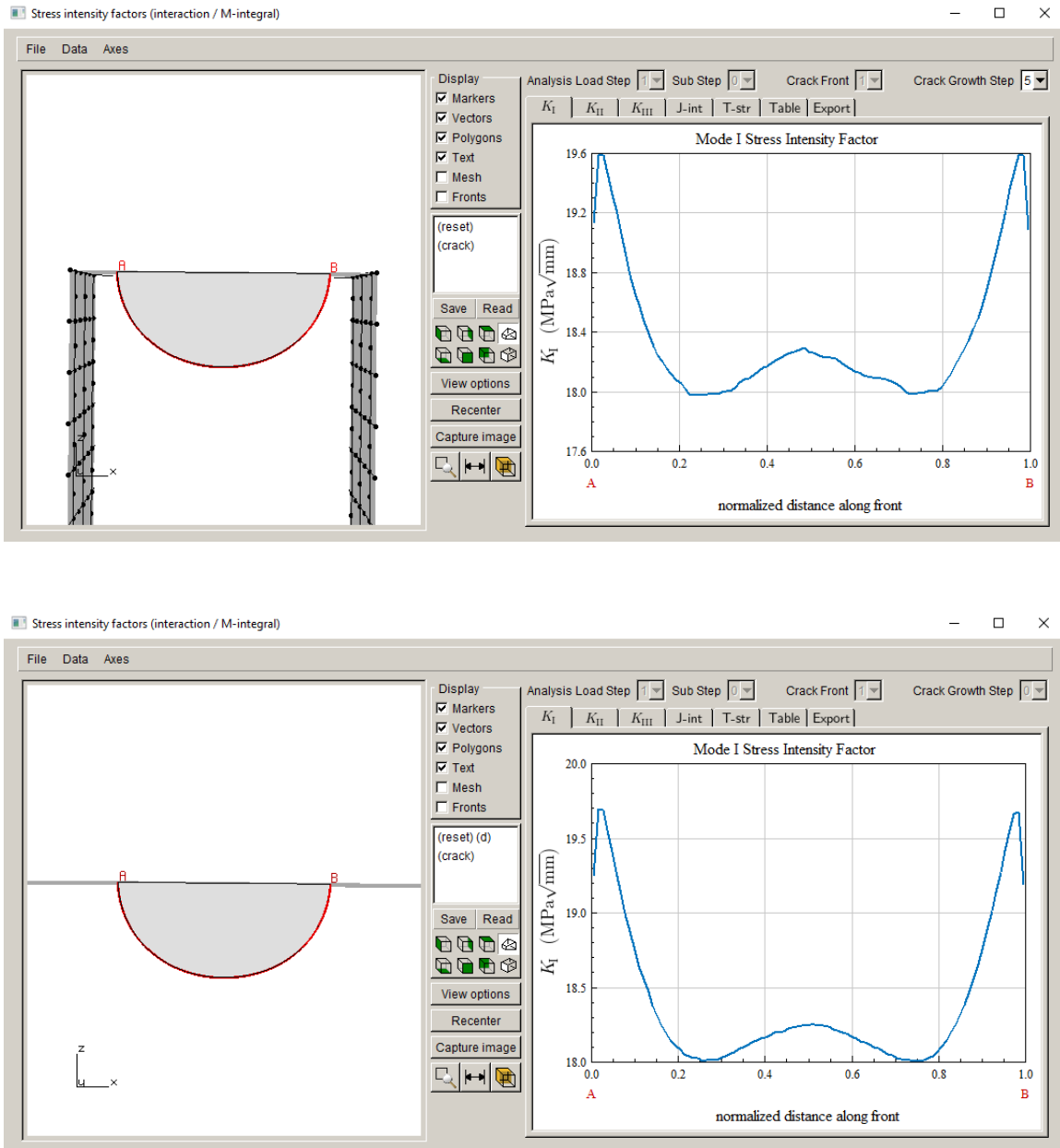

Figure 2.84 Step 5 Mode I SIFs for the original submodel analysis (top) compared with the new results using the full model (bottom).

After propagating the crack an additional six steps, we can combine the SIF history for the two analyses. We do this in the next step using **Create Growth History** under the **Advanced** menu.

### **Step 10.3: Combine SIF Histories**

Start FRANC3D, select the **File** → **Open** menu option, and select the *Sierra\_Cube\_sub\_STEP\_005.fdb* file. From the **Advanced** menu, select **Create Growth History**, Fig 2.85. The dialog shown in Fig 2.86 is displayed. Note that the initial crack is labeled as CrackStep\_1 and then there are five steps of growth after that. You can use the **Plot** menu option to display the crack fronts, Fig 2.87.

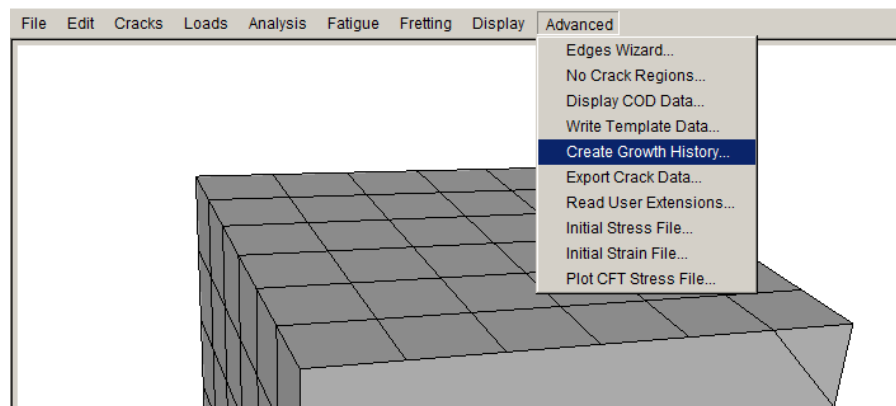

Figure 2.85 FRANC3D Advanced menu.

Using the **File** menu in the Create Growth History dialog, select **Save History**, Fig 2.88, and save the SIF history to a *.fcg* file, called *Sierra\_Cube\_sub\_steps.fcg* here. Close the dialog using the **Cancel** button, and then close the model in FRANC3D using the **File** → **Close** option.

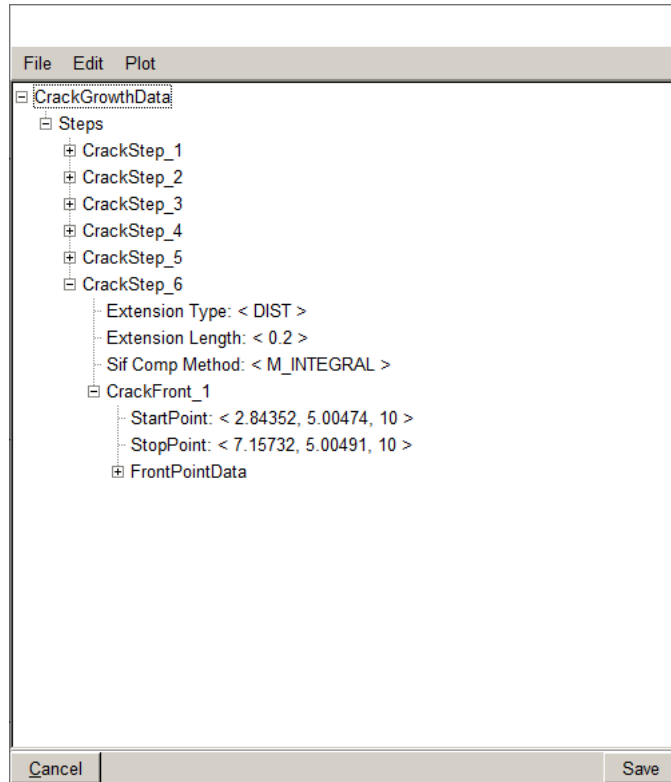

Figure 2.86 Create Growth History dialog – steps 0-5.

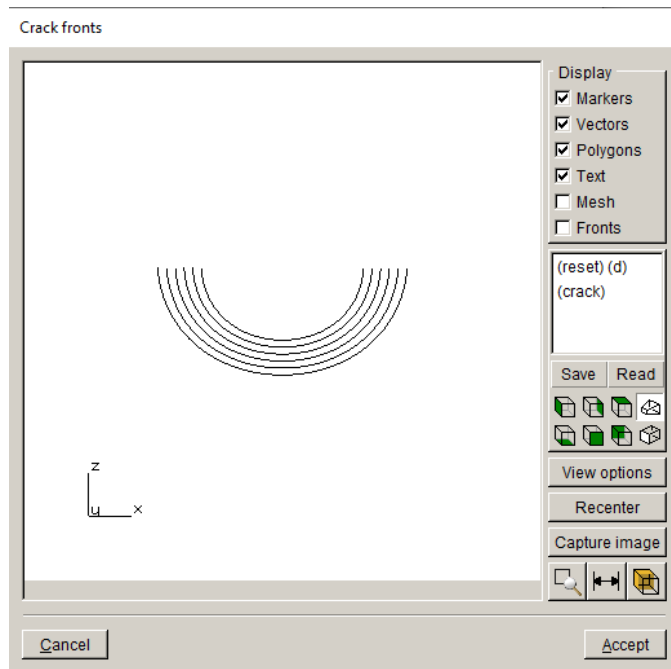

Figure 2.87 Create Growth History dialog fronts 0-5.

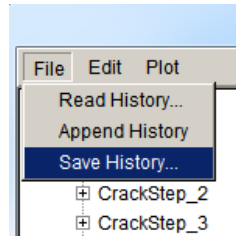

Figure 2.88 Create Growth History dialog File menu.

Now open the *Sierra\_Cube\_full\_STEP\_011.fdb* file (our last step of crack growth) using the **File** → **Open** option. As with the submodel, save the history using the Create Growth History dialog. The SIF history for the full model is shown in Fig 2.89. Note that CrackStep\_1 in the full model gives the same SIFs as CrackStep\_6 in the submodel; however, CrackStep\_1 in the full model includes crack extension data.

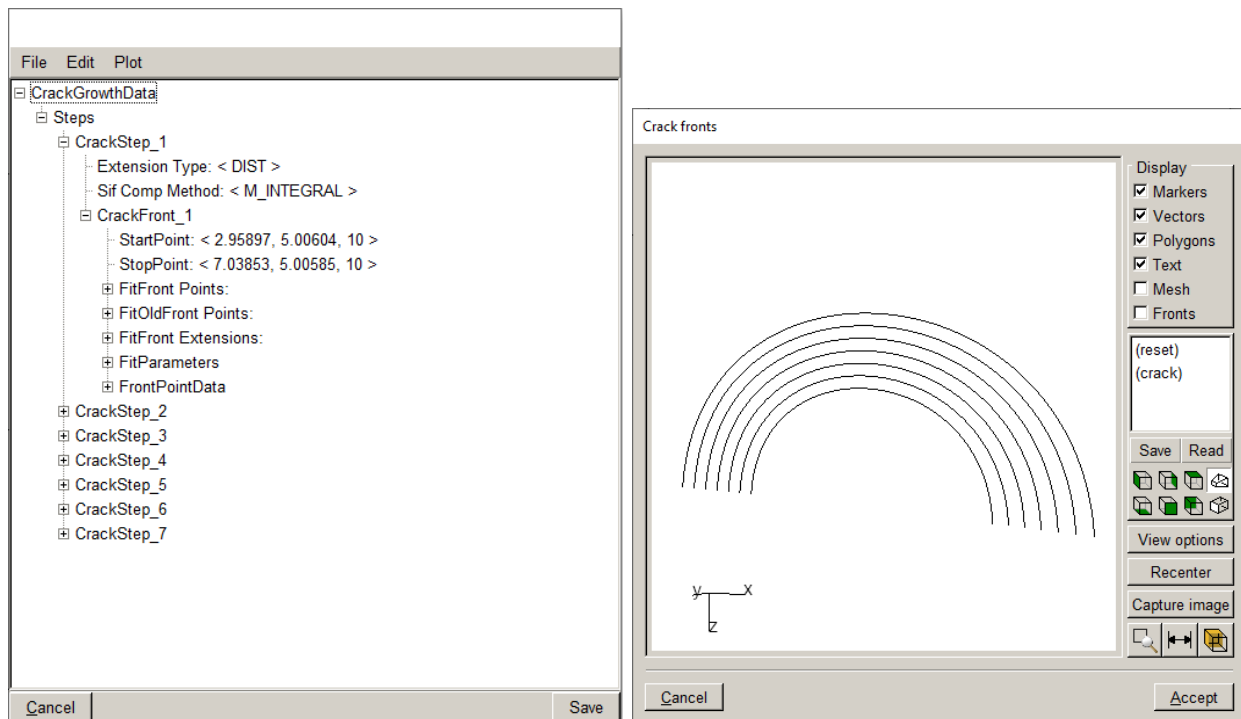

Figure 2.89 Create Growth History dialog – full model fronts 5-11.

Save the full model SIF history to a *.fcg* file, called *Sierra\_Cube\_full\_steps.fcg*. Close the Create Growth History dialog and close the model. This leaves the FRANC3D main model window

empty. Select the **Advanced** → **Create Growth History** menu option to display the dialog. It does not have any CrackGrowthData.

Use the **File** menu in the Create Growth History dialog and select **Read History**, Fig 2.90. Select the *Sierra\_Cube\_sub\_steps.fcg* file. Then using the same menu, select **Append History** and select the *Sierra\_Cube\_full\_steps.fcg* file. Note that there will be twelve steps of crack data at this stage, Fig 2.91. We need to delete CrackStep\_6 from the Submodel data as it does not include extension data. We highlight CrackStep\_6, and then right-click the mouse to display the submenu, Fig 2.92. Select **Delete Crack Step** and it will be removed, leaving eleven crack steps. You can plot the combined fronts, Fig 2.93.

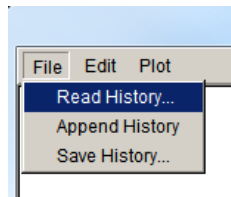

Figure 2.90 Create Growth History dialog – File menu.

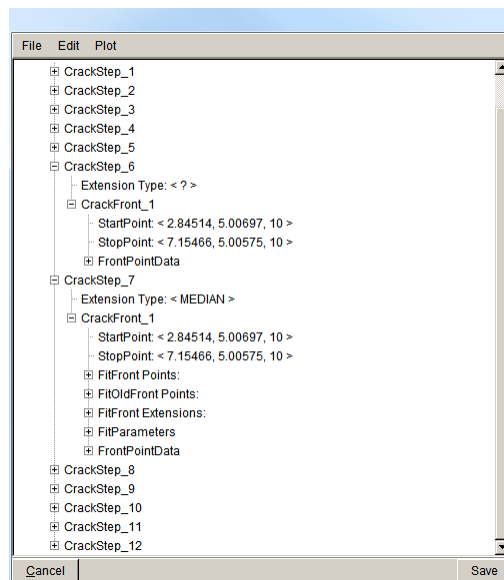

Figure 2.91 Create Growth History dialog – combined SIF history data.

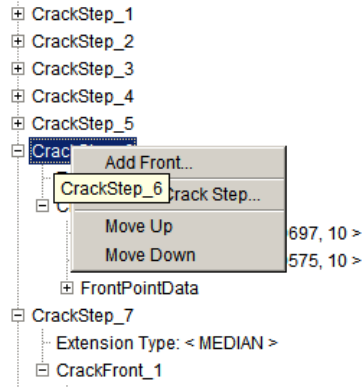

Figure 2.92 Right-mouse button click on the CrackStep\_6 to delete.

Use the **File** menu in this dialog (Fig 2.91) to save the combined SIF history to a *.fcg* file, called *Sierra\_Cube\_combined\_steps.fcg*. The dialog (Fig 2.91) can be closed by selecting the **Cancel** button at the bottom; selecting the **Save** button prompts you save the history data to file.

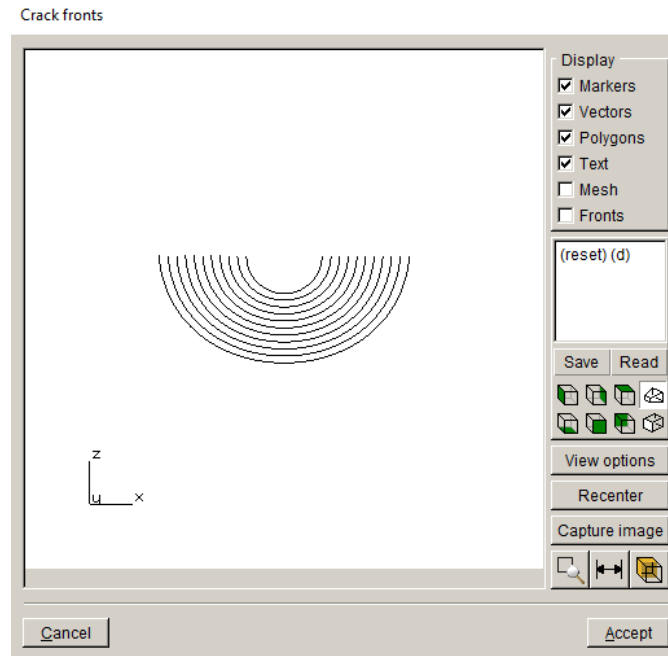

Figure 2.93 Create Growth History dialog – combined crack fronts.

The combined SIF history data can be imported into the Fatigue Life module using the **Read SIF Data** button, Fig 2.94. Once you set or read parameters, you can plot cycles; see Step 9.3.

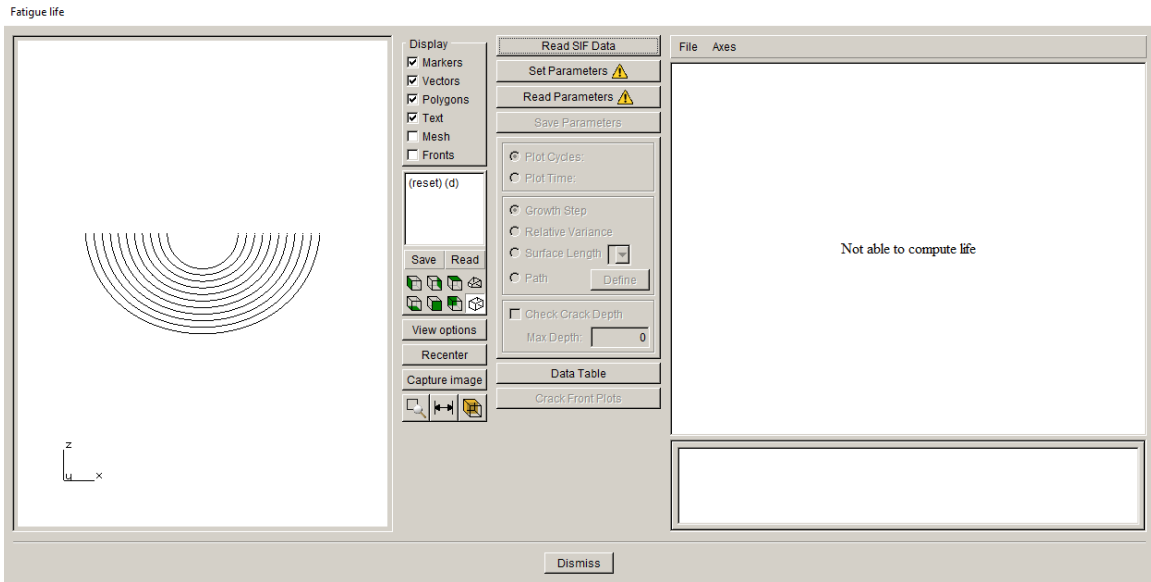

Figure 2.94 Fatigue Life dialog.